

1. Sampul Journal dan Informasi Dewan Redaksi

Not secure | ejournal.kemenerin.go.id/jli/about

Submissions Harga Bahan Kimia... Piglin - Official Min... Jual MERCK Gadoli... gadolinium indones... Tugas pertemuan 9 (6) WhatsApp



Jurnal Litbang Industri BARISTAND INDUSTRI PADANG

p-ISSN: 2252-3367 e-ISSN: 2502-5007
Accredited by LIPI No: 787/Akred/P2MI-LIPI/11/2017 until October 2022
Accredited by KEMENRISTEKDIKTI No: 21/E/KPT/2018 until December 2020



[HOME](#) [ABOUT](#) [LOGIN](#) [REGISTER](#) [SEARCH](#) [CURRENT](#) [ARCHIVES](#) [ANNOUNCEMENTS](#) [EDITORIAL BOARD](#) [REVIEWER ACKNOWLEDGEMENT](#) [SITE MAP](#) [CONTACT US](#)

JOURNAL CONTENT

Search

Search Scope
All

Search

Browse

- » By Issue
- » By Author
- » By Title
- » Other Journals

Journal Help

LANGUAGE

Select Language
English

Submit

FONT SIZE

A⁻ A A⁺

INFORMATION

- » For Readers
- » For Authors
- » For Librarians

KEYWORDS

Banana activated carbon
adsorption **antioksidan**
banana flour biodiesel cotton
effervescent extraction fenol
fermentation **gambier**
gambier extract **gambir**
hidrolisis katekin palm oil
quality rice husk sugar tannin

CURRENT ISSUE

ATOM	1.0
RSS	2.0
RSS	1.0

Home > About the Journal

About the Journal

People

- » Contact
- » Editorial Team
- » Reviewer Acknowledgement

Policies

- » Focus and Scope
- » Section Policies
- » Peer Review Process
- » Publication Frequency
- » Open Access Policy
- » Archiving
- » License Policy
- » Reference Management Policy





Submissions





- » Online Submissions
- » Author Guidelines
- » Copyright Notice
- » Privacy Statement
- » Author Fees





Other

- » Journal Sponsorship
- » Journal History
- » Site Map
- » About this Publishing System
- » Statistics

Our journal indexed by:

OPEN JOURNAL SYSTEMS

Submit Articles

Author Guidelines

Ethical & Copyright Statement

Aim and Scope

Publication Ethics

Plagiarism policy

Author Fees

Indexing Sites

USER

Username

Password

Remember me

Login

NOTIFICATIONS

- » View
- » Subscribe

TEMPLATE

NEW Journal Template

TOOLS

Grammar checks by:

grammarly

Reference management tool:

MENDELEY

VISITOR

ID	110700	US	14856
IN	552	RU	426
MY	399	SG	387
HK	195	CN	177
JP	149	EU	127

Newest: CW You: ID

Today: 14

Month: 14





Total: 138724

Supercounters.com

STATCOUNTER
00126668
View My Stats

Copyright © Baristand Industri Padang, 2015. Powered By OJS

Theme design credited to MEV edited by JLI

This work is licensed under a Creative Commons Attribution-NonCommercial-ShareAlike 4.0 International License

2. Daftar Isi satu Volume dan Isu

Not secure | ejournal.kemenerin.go.id/jli

Submissions Harga Bahan Kimia... Piglin – Official Min... Jual MERCK Gadoli... gadolinium indones... Tugas pertemuan 9 (6) WhatsApp

Jurnal Litbang Industri

HOME ABOUT LOGIN REGISTER SEARCH CURRENT ARCHIVES ANNOUNCEMENTS EDITORIAL BOARD REVIEWER ACKNOWLEDGEMENT SITE MAP CONTACT US

JOURNAL CONTENT

Search

Search Scope: All

Browse:

- By Issue
- By Author
- By Title
- Other Journals

Journal Help

LANGUAGE: English

FONT SIZE

INFORMATION

- For Readers
- For Authors
- For Librarians

KEYWORDS

Banana activated carbon adsorption **antioksidan**
 banana flour biodiesel cotton effervescent extraction fenol
 fermentation **gambier**
 gambier extract **gambir**
 hidrolisis katekin palm oil
 quality rice husk sugar tannin

CURRENT ISSUE

ATOM 1.0
 RSS 2.0
 RSS 1.0

Home > Vol 11, No 2 (2021)

Jurnal Litbang Industri

Jurnal Litbang Industri (JLI) is a scientific journal published regularly twice a year in June and December. JLI contains primary articles or reviews are sourced directly from results of industrial research such as processing of agricultural products, food processing, fishing industry, mining industry, industrial standardization, and pollution control. All submissions are reviewed by qualified reviewers in their field.

JLI is published by Institution of Research and Standardization of Industry – Padang, Agency of Research and Development of Industry, The Ministry of Industry, Indonesia.

JLI was accredited by Indonesian Institute of Science (LIPI) number: 787/Akred/P2MI-LIPI/11/2017 according to the decision letter number: 1054/E/2017, started from October 2017 - October 2022 (attachment).

JLI has changed the old template with the new one for improvements. The new template can be downloaded and will be started since volume 8 number 1, June 2018 (attachment).

In July 2018, JLI (Jurnal Litbang Industri / Industrial Research and Development Journal) was accredited by Ministry of Research, Technology and Higher Education of the Republic of Indonesia (KEMENRISTEKDIKTI) number: 21/E/KPT/2018 for five years, started from Vol. 6 No. 1 2016 - Vol. 10 No. 2 2020. In 18 September 2020, JLI applied for re-accreditation and based on The Decree of The Minister of Research and Technology / Head of The National Research and Innovation Agency No. 200/M/KPT/2020 23 December 2020, JLI was re-accredited with rank 2 (Sinta 2) for 5 (five) years for the period Volume 10 No. 1 June 2020 - Volume 14 No. 2 December 2024 (attachment).

OPEN JOURNAL SYSTEMS

- Submit Articles
- Author Guidelines
- Ethical & Copyright Statement
- Aim and Scope
- Publication Ethics
- Plagiarism policy
- Author Fees
- Indexing Sites

USER

Username

Password

Remember me

Login

NOTIFICATIONS

» View
» Subscribe

TEMPLATE

NEW Journal Template

TOOLS

Grammar checks by:

Reference management tool:

VISITOR

ID	110682	US	14856
IN	552	RU	426
MY	399	SG	387
HK	195	CN	177
JP	149	EU	127
Newest:	CW	You:	ID
Today:			56
Month:			2900
Total:			138706

p-ISSN: 2252-3367 | e-ISSN: 2502-5007 | DOI Prefix: [10.24950](#)

Announcements

Jurnal Litbang Industri Call for Papers

We invite you to submit your papers of original research and reviews to *Jurnal Litbang Industri (Journal of Industrial Research and Development)*

Papers published are free of charge. Manuscripts should be submitted online at [submission](#).

Please do not hesitate to [contact us](#) if you have any questions, we will be glad to help you.

Papers published are free of charge.

Posted: 2017-02-23 [More...](#)

[More Announcements...](#)

Vol 11, No 2 (2021)

Jurnal Litbang Industri Volume 11 Nomor 2 Desember Tahun 2021
 Balai Riset dan Standardisasi Industri Padang

Table of Contents

Front Pages

Front Matter Jurnal Litbang Industri Vol. 11 No. 2 Desember Tahun 2021

PDF
i-ii
iii

Table of Contents

Front Pages

Front Matter Jurnal Litbang Industri Vol. 11 No. 2 Desember Tahun 2021



i-ii

Abstrak Jurnal Litbang Industri Vol. 11 No. 2 Desember Tahun 2021



iii-xii

Articles

Peningkatan daya buih susu skim sebagian rekombinasi dengan penggunaan penstabil

Ahmad Johari, Sugiyono Sugiyono, Dede Robiatul Adawiyah

PDF (INDONESIAN)
79-89

Design of mold press for the manufacturing of silica sand pellet form

Dedikarni Panuh, Rieza Zulrian Aldo, Amir Surya Hidayah

PDF
90-96

Pengaruh alkalisasi pada pasta kakao terhadap rendemen minyak hasil pengempaan

Dewi Arziyah, Sri Mutiar

PDF (INDONESIAN)
97-102

Perlakuan ozon dan sonokimia untuk degradasi residu mankozeb pada cabe hijau (Capsicum annum L.)

Safni Safni, Elma Fadrita Rahman, Deswati Deswati, Salmariza Sy

PDF (INDONESIAN)
103-109

Produksi karbon aktif arang tempurung kelapa menggunakan kombinasi metode aktivasi secara kimia dan steam tekanan rendah

Ahmad Muhajir, Izarul Machdar, Mariana Mariana

PDF (INDONESIAN)
110-116

Utilization of mensiang (Actinoscorpis grosus L.) as a cellulose-rich material for furfural synthesis

Fransiska Angelina G Rezekinta, Anwar Kasim, Novizar Nazir, F Failisnur

PDF
117-123

Preparation of chitosan-based nanofiber mats containing Soluplus® as a potential polymeric carrier by electrospinning process

Rizka Yulina, Irene Bonadies, Giovanni Dal Poggetto, Paola Laurienzo

PDF
124-130

Pengaruh penambahan Carboxyl Methyl Cellulose (CMC) dan asam sitrat terhadap mutu dan ketahanan simpan susu jagung

Citra Setiawati, Kamsina Kamsina, Inda Three Anova, Firdausni Firdausni, Yulia Helmi Diza

PDF (INDONESIAN)
131-137

Produksi garam di lahan geomembran: Perhitungan kapasitas produksi, mutu dan perbandingannya dengan garam tradisional

Lancy Maurina, Mahlinda Mahlinda, Abdul Thalib, Ridho Kurniawan

PDF (INDONESIAN)
138-144

Pengaruh ukuran saringan dan konsentrasi gula terhadap sifat fisika kimia konsentrat sari buah kundur (Benincasa hispida (Thunb.) Cogn)

Inda Three Anova, Kamsina Kamsina, Firdausni Firdausni, Yulia Helmi Diza, Yurnita Yurnita

PDF (INDONESIAN)
145-150

Back Pages

Back Matter Jurnal Litbang Industri Vol. 11 No. 2 Desember Tahun 2021

PDF
xiii-xvi

Our journal indexed by:



ID	110682	US	14856
IN	552	RU	426
MY	399	SG	387
HK	195	CN	177
JP	149	EU	127
Newest:	CW You:	ID	
Today:		56	
Month:		2900	
Total:		138706	
Supercounters.com			

STATCOUNTER
00126653
View My Stats

Our journal indexed by:



Copyright © Baristand Industri Padang, 2015. Powered By OJS

Theme design credited to MEV edited by JLI



This work is licensed under a [Creative Commons Attribution-NonCommercial-ShareAlike 4.0 International License](https://creativecommons.org/licenses/by-nc-sa/4.0/)

Design of mold press for the manufacturing of silica sand pellet form

Perancangan mold press untuk menghasilkan bentuk pelet pasir silika

Dedikarni Panuh*¹, Rieza Zulrian Aldio¹, dan Amir Surya Hidayah¹

¹ Program Studi Teknik Mesin Universitas Islam Riau

Jl. Kaharuddin Nasution Km 11 No. 113 Perhentian Marpoyan, Pekanbaru, Indonesia

* e-mail: dedikarni@eng.uir.ac.id



INFO ARTIKEL

Sejarah artikel:

Diterima :

24 Maret 2021

Direvisi :

23 November 2021

Diterbitkan :

30 Desember 2021

Keywords:

mold press;

pellet;

silica sand

ABSTRACT

Currently, the ceramic industries is utilizing many natural mineral resources. The purpose of this study is to design and manufacture the tool; a mold press pellet or silica sand mold and to obtain the results of silica sand pellets that are affected by varying pressure. The materials used for the tools were STM A276, Type 410 steel. ST60 martensite. SS400 steel was used to made the round plate at a mold position. This study produced mold with dimensions of 25.45 mm of diameter, height of 89 mm, volume at 45.07 cm³ with a mold circle area of 5.06 cm² and punch cross-sectional area of 452.16 mm². The maximum pressing force on the mold was 49050 N, the normal stress result was 108.47 MPa, the strain value was 3.8 mm / mm, the modulus of elasticity value was 28.54 MPa, the mold material had a maximum limit of 812,871 MPa, indicating that the mold material used was very good. This silica sand pellet mold produced can be utilized for the development of fuel cell and composite materials.

ABSTRAK

Industri keramik banyak memanfaatkan sumber daya alam mineral yang terdapat di Indonesia. Tujuan penelitian ini adalah untuk merancang dan membuat alat serta mendapatkan hasil berupa pelet pasir silika. Oleh karena itu sebuah mold press pellet dirancang untuk mendapatkan mold yang berkualitas dengan metode penekanan dingin. Bahan yang digunakan untuk membuat (mold, tuas punch, plat silinder, dan bantalan penekan bawah) adalah ASTM A276, Baja Tipe 410. Baja stainless matrensit ST60 digunakan untuk membuat (kedudukan punch, dan kedudukan mold). Baja SS400 digunakan untuk membuat (Plat bulat pada kedudukan mold). Dalam penelitian ini dihasilkan mold dengan dimensi atau ukuran diameter 25,45 mm dan tinggi 89 mm. Volume silinder mold adalah 45,07 cm³ dengan luas lingkaran mold 5,06 cm². Luas penampang punch ialah 452,16 mm², gaya penekan maksimal pada mold ialah 49050 N. Hasil tegangan normal ialah 108,47 MPa, nilai regangan ialah 3,8 mm/mm, nilai modulus elastisitas ialah 28,54 MPa, bahan material mold yang digunakan memiliki tegangan maksimal sebesar 812,871 MPa, material mold yang digunakan sangat baik. Berat beban reaksi tumpuan vertikal A dan B ialah 2500 kg dan momen maksimal yang didapat ialah -612500 kg.mm. Cetakan pellet pasir silika yang dihasilkan dapat dimanfaatkan dalam pengembangan bidang fuel cell dan bahan material komposit.

1. Introduction

There are many clays, feldspar, kaolin dan silica sand distributed in various regions in Indonesia, potentially made them as materials for ceramic industries. Currently, ceramic industries utilizing these natural resources. Silica itself is the most popular material used in highly accurate dimensions of castings at more favorable cost than other materials (Thiel, 2011). Despite its high annual output, silica's utilization rate is still low (Tie, 2012).

Silica is a form of chemical compound with SiO_2 molecule, and it can be found in the form of mineral silica which can be obtained from sand mining in various regions. Many investigations regarding silica in the form of silicon nitride in nanorod, nanofiber and nanowire are also conducted in recent years (Bechelany et al 2007; Chaudhari, 2011). Thermo mechanical properties of molded products will improved when reinforced with particle such as silica (Chandran and Waigaonkar, 2017). Silica also used in form of gel as antifungal agent for bamboo (Yang, 2019).

In the industries, silica sand commonly use in glass, cement, ceramic and sandpaper manufacturing. It also commonly used as additive or mixing component in manufacturing processes, high-temperature material (refractory), fiber cement silica board industries and etc. It also used as bearing, mainly known as silica-bearing additive (Pattnaik, 2012). Additionally, silica is preferred because the core removal won't be needing any chemical substances. Thus, silica sand is commonly utilized in research and development of material sciences (Latif et al., 2014).

Another use of silica is known as nano-silica, where it has been used as nano fillers for polymer's coatings to enhance the additive performance (Shi et al. 2013). Other examples are nano silicon dioxide is used in coatings for the preservation of food (Sun et al. 2016). Then nanosilica is also commonly used to prolong fruit shelf life and for the growth of Chinese winter jujube (Kou et al., 2016). Nanosilica/chitosan also used for controlling gray mold of grapes (Youssef et al., 2019; Youssef and Roberto, 2021).

Many research on silica sand in pellet form are conducted, with the silica sand pellet made from mold. The mold design will affect the hardness and form of pellet (Astika et al., 2010). Other experiment involving the silica molds are on the silica stiffness (Lashkaripour, 2003) and sand mold or cores. Pressure on the pellet will affect the porosity and permeability of that pellet (Fadli et al., 2021).

Therefore, there is a need of further research on the designing of silica pellet mold. The mold (with pressing motion process) will be permanent for a repeated uses to save the production cost. The pellets consists of silica sand mixed with bonding material for the test of the silica sand composite's characteristics. The pellet mold also used as samples in pharmaceutical researches, such as tablet and etc.

This tool is expected not only to helps the researchers in material science field, but also those who specialized in renewable energy field, such as fuel cell and solar cell.

2. Method

2.1. Flowchart

Here are the steps taken in this research, Figure 1 shows the flow of the designing process.

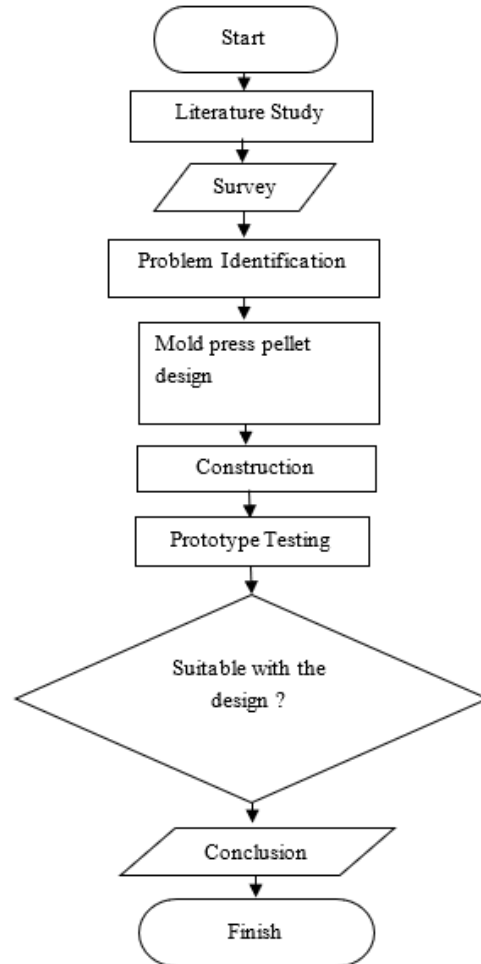

Figure 1. Flowchart

2.2. Design sketch of mold press pellet

Figure 2 below shows the design of the mold press pellet.

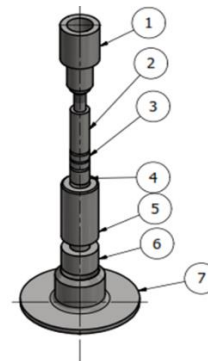

Figure 2. Design of the mold press pellet (1) Punch holder, (2) Punch lever, (3) Upper cylinder plate, (4) Lower cylinder plate, (5) Mold, (6) Lower Pressing pads, (7) Mold holder

2.3. Equipment & materials

Here are the equipments and materials used for the manufacturing of the mold press pellet (1) Turning machine, (2) Milling machine, (3) Welding machine, (4) Grinding machine, (5) Hydraulic press machine, (6) ST 60 Steel, (7) ASTM A276 type 410 Stainless steel martensite, (8) SS 400 Steel.

3. Results and discussion

The results of the mold is based on the dimensions of the mold's parts. Calculation of those parts is a part of the designing process.

3.1. Mold press pellet specifications

The Specifications of mold press pellet created in dimensions and materials used in the design with maximum capacity of weight at hydraulic cylinder at 10.000 kg.

- Mold press dimensions
= 89 x 47 x 25,45 (mm)
- Plate thickness of mold press
= 21,55 (mm)
- Length of torque bar
= 250 (mm)
- Punch dimensions
= 173 x 33 x 24 (mm)
- Mold materials
= ASTM A276 Type 410

3.2. Product design

On the design of the mold, there is a need for the entrance and exit of the pellet resulted by the press. After the press done and pellet bonded, the pellet will be out and ready for the sintering.

3.3. The Selection of mold press design

Figure 3 shows the concept of the mold press. The concept is selected based on the aspect of the easier and lighter pressing process. It also considered how to insert the silica sand into the press mold to get the desired silica sand pellets shape.

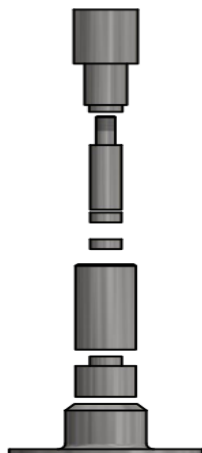

Figure 3. Mold press concept

3.4. Construction of mold press pellet

The construction processes are divided into some parts of the mold.

3.4.1. Punch position

The finished punch's position is the part that touched directly by the hydraulic press machine. It will received the load or pressure that is given by the hydraulic press, then deliver the pressure onto the mold. The materials used were ST 60 steel.

3.4.2. Punch lever

The punch lever is the pressing part of the mold to put pressure on the mold to make silica sand pellets. The material used was Type 410 stainless steel.

3.4.3. Cylinder plate

Cylinder plate is the supporting part between the silica sand pellets so that they do not break and to keep them formed as desired. Materials used were ASTM type 410 martensitic steel.

3.4.4. Mold

The mold is the main part for making or contain silica sand pellet molds. Materials used were ASTM type 410 martensitic steel.

3.4.5. Low pressure bearing

The low pressure bearing is the lower part of the mold, acts as the holder of the received pressure by the hydraulic press. Materials used were ASTM type 410 martensitic steel.

3.4.6. Mold position

The position of the finished mold is for the place of the silica sand pellet, pressed in a safe position that would not shift and to avoid unwanted things mixed during pressing. In making this mold position, 2 different materials were used, they are ST 60 steel material for the top cylinder and SS 400 steel for the bottom cylinder plate.

3.5. Design calculations

Calculating the volume of the cylinder by :

$$V = \pi \times r^2 \times t \tag{1}$$

V = volume of cylinder (cm³)

r² = radius (cm²)

t = tube height (cm)

Calculation :

$$V = \pi \times r^2 \times t \tag{2}$$

$$= 3,14 \times (1,27)^2 \text{ cm} \times 8,9 \text{ cm}$$

$$= 45,07 \text{ cm}^3$$

Area of Circle

$$A = \pi \times r^2 \tag{3}$$

L = Area of circle (cm²) .

r² = radius (cm²)

t = Tube height (cm)

with d = 2,545 (cm) :

$$r = \frac{D}{2}$$

$$= \frac{2,545 \text{ cm}}{2}$$

$$= 1,27 \text{ cm} \tag{4}$$

Use formula (3) :

$$A = 3,14 \times (1,27)^2 \text{ cm}$$

$$= 5,06 \text{ cm}^2$$

3.6. Hydraulic cylinder on the punch

There are some calculations regarding the punch lever, they are the parts that connected to the hydraulic, shown by Figure 4 below.

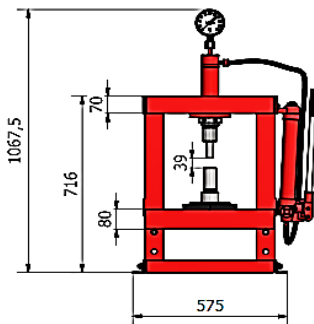

Figure 4. Hydraulic on punch

3.7. Area of punch

The formula for the calculation of the area is shown on equation 6 below :

$$A = \frac{\pi}{4} \cdot d^2 \tag{6}$$

A= Area of punch (mm²)

d² = Diameter of punch (mm²)

Calculation :

$$A = \frac{3,14}{4} \cdot 24^2$$

$$= 452,16 \text{ mm}^2$$

3.8. Maximum force on the mold

For the calculation of the force on the mold, equation 7 below is used :

$$F \text{ max} = m \cdot g \tag{7}$$

F max = Force (N)

m = mass (kg)

g = Gravitation (m/s²)

Calculation :

$$F \text{ max} = 5000 \text{ kg} \times 9,81 \text{ m/s}^2$$

$$= 49.050 \text{ (N)}$$

Maximum value of force could be applied on the mold is 49.050 N.

3.9. Mechanical properties due to load

To measure the mechanical properties due to the load applied on the silica sand pellet, there are 3 variable to measure in this case. They are the stress, strain and elasticity. Figure 5 below shows the illustration of stress test.

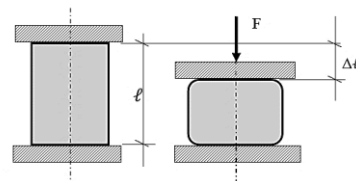

Figure 5. Static press test (Zainal et al., 2018)

3.10. Normal stress (MPa)

To measure the normal stress, equation 8 below is used :

$$\sigma = \frac{F}{A} \text{ (MPa)} \tag{8}$$

σ = Normal stress (MPa)

F = Load/Force (N)

A = Area of punch applied by the load (mm²)

Calculation :

$$\sigma = \frac{49050 \text{ N}}{452,16 \text{ mm}^2}$$

$$= 108,47 \text{ N/mm}^2$$

$$= 108,47 \text{ MPa}$$

With the normal stress value of 108,871 MPa, the mold should be desirable since it has maximum value of stress at 812,871 MPa. The mold materials used can be considered very good.

3.11. Strain (ε)

To measure the strain based on the load, equation 9 below is used :

$$\epsilon = \frac{\Delta l}{l} \tag{9}$$

$$\Delta l = l_0 - l_1$$

$$\Delta l = 48 \text{ mm} - 10 \text{ mm}$$

$$\Delta l = 38 \text{ mm}$$

ε = Strain (mm/mm)

Δl = Difference of length (mm)

l₀ = Initial length (mm)

l₁ = Final length after test (mm)

Calculation :

$$\varepsilon = \frac{38 \text{ mm}}{10 \text{ mm}} = 3,8 \text{ mm/mm}$$

With the value of strain at 3,8 mm/mm and strain of the mold materials at 43,56 mm/mm, there was a considerable gap between them.

3.12. Modulus of elasticity

Equation 10 below is used to calculate the modulus of elasticity of the mold :

$$E = \frac{\sigma}{\varepsilon} \tag{10}$$

E = Modulus of elasticity (MPa)

σ = Normal stress (MPa)

ε = Strain (mm/mm)

Calculation :

$$E = \frac{108,47 \text{ MPa}}{3,8 \text{ mm/mm}} = 28,54 \text{ MPa}$$

Value of the modulus of elasticity is 28,54 MPa, which making the mold materials was very good since it had maximum stress value at 812,871 MPa.

3.13. Identifying the strength of construction

After determining the dimensions of the mold, the construction calculations are carried out. Construction calculations including mechanical parts and control parts can be explained, namely:

3.13.1. Mechanical parts

The mechanical part is an important part of the silica sand pellet press mold, which consists of the following components:

3.13.1.1. Construction (frame)

The construction of the tool was carried out to determine the strength of the silica sand pellet mold press when it was used as a place and to support the components used.

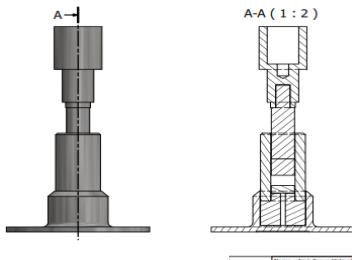

Figure 6. Construction of mold press

So that calculating the construction strength on the silica sand pellet press mold tool, can be seen in the side view, rear view and view of the tool frame. Figure 7 shows the side view of the mold press.

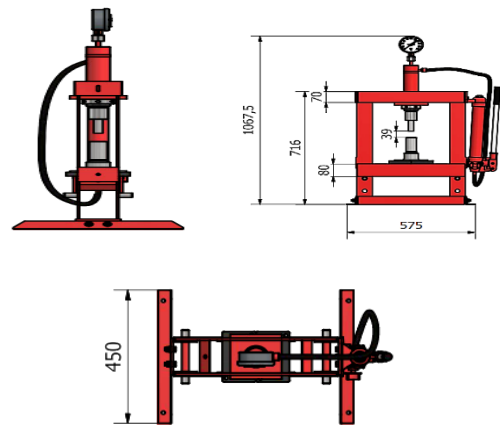

Figure 7. Side, front and top view

As for Figure 7 shows, the front view of mold with dimensions of 490 mm width and height of 720 mm. Figure 7 also shows the top view of the mold press with height of the hydraulic press at 450 mm. Based on the data in Figure 7 above, the frame construction has a centered reaction on the iron plate. So that it can be calculated and then compared between the amount of load P on the machine frame. The forces acting on the portal or the intermediate support reaction, the RA vertical support reaction and the RB support vertical support reaction are then calculated to obtain the result.

The frame construction has a centered reaction on the iron plate. So that it can be calculated and then compared between the amount of load P on the machine frame. The forces acting on the portal or the intermediate support reaction, the RA vertical support reaction and the RB support vertical support reaction are then calculated to obtain the result, namely:

3.13.1.2. Vertical support reaction A

The equation is used to calculate the vertical support reaction A to get the RB calculation results in Figure 8.

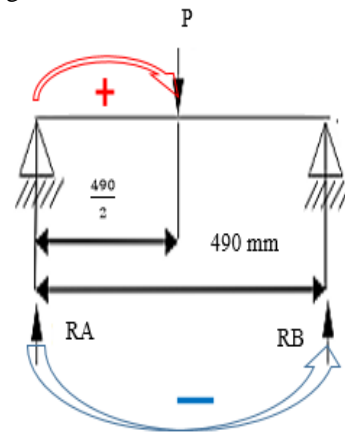

Figure 8. Vertical support reaction A

$$\begin{aligned} \Sigma M_A &= 0 \\ \Sigma M_A &= P \cdot \frac{L}{2} + (-RB) \cdot L = 0 \\ P \cdot \frac{L}{2} &= RB \cdot L \\ P \cdot \frac{L}{2} \cdot \frac{1}{L} &= RB \end{aligned}$$

$$R_B = \frac{1}{2} P \quad (11)$$

R_B = Reaction support (kg)
 P = Load (kg)
 L = Length of beam (mm)
 Maka:

$$R_B = \frac{1}{2} \cdot P \quad (12)$$

$$R_B = \frac{1}{2} \cdot 5000 \text{ kg}$$

$$R_B = 2500 \text{ kg}$$

Result of the calculation of the vertical support reaction A to get the RB calculation result is 2500 kg.

3.13.1.3. Vertical support reaction B

The equation used to calculate the vertical support reaction B is in Figure 9. The result of the calculation of the vertical support reaction A to get the RA calculation result is 2500 kg. Those are the weight between the vertical support reaction A and the vertical B. The load (P) is divided by two, then the calculation results get the support reaction load is 2500 kg.

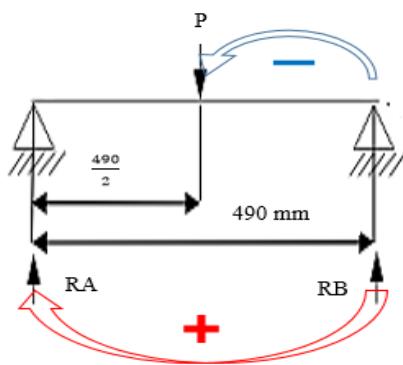

Figure 9. Vertical support reaction B

$$\begin{aligned} \sum M_B &= 0 \\ \sum M_B &= P \cdot \frac{L}{2} + R_A \cdot L = 0 \\ P \cdot \frac{L}{2} &= R_A \cdot L \\ P \cdot \frac{L}{2} \cdot \frac{1}{L} &= R_A \\ R_A &= \frac{1}{2} \cdot P \end{aligned} \quad (13)$$

R_A = Reaction support (kg)
 P = Load (kg)
 L = Length of beam (mm)
 Maka:

$$R_A = \frac{1}{2} \cdot 5000 \text{ kg}$$

$$R_A = 2500 \text{ kg}$$

3.13.1.4. Maximum moment

Calculating the Maximum Moment on a simple beam with a load centered in the middle part of the beam. A

simple beam forces diagram with a centered load can be seen in Figure 10.

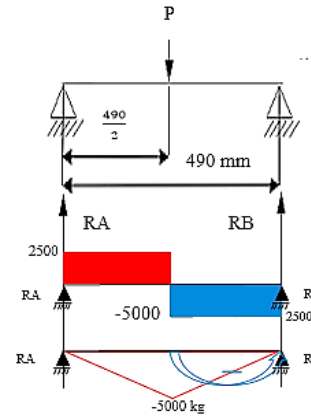

Figure 10. Maximum moment

$$M_{max} = -R_B \cdot \frac{1}{2} L$$

Or,

$$M_{max} = -\frac{1}{2} P \cdot \frac{1}{2} L$$

$$M_{max} = -\frac{1}{4} \cdot P \cdot L$$

(14)

M_{max} = Max moment (kg.mm)
 P = Load (kg)
 L = Beam's length (mm)

The calculation :

$$M_{max} = -\frac{1}{4} \cdot 5000 \text{ kg} \cdot 490 \text{ mm}$$

$$M_{max} = -612500 \text{ kg.mm}$$

The result of the calculation of the Maximum Moment on a simple beam with a centered load in the middle of the beam is -612500 kg.mm.

4. Conclusion

From this study, the materials used are ST60 steel, 410 type of stainless steel and SS400 steel. They are used as the parts on the constructed tools. ST60 used as punch position and mold position. 410 type of stainless steel used as mold, punch, cylinder plate, and bottom pressure bearing, consists of 11.5% chromium and has good corrosion resistance properties. As for SS400 steel, used as round plate at mold position.

The results of the calculation of the mold press are mold cylinder volume and mold circle area are 45.07 cm³ and 5.06 cm² respectively. The calculation results obtained on the cross-sectional area of the punch is 452.16 mm² and the maximum pressure force on the mold press is 49050 N.

The results of the calculation of the mechanical behavior due to static loads, among other things, the normal tension (σ) is 108.47 MPa, strain (ϵ) is 3.8 mm / mm, the modulus of elasticity (E) is 28.54 MPa. The mold material used is more than capable since it has a maximum limit of 812.871 MPa. The material for mold used can be considered as very good.

The result of the weight of the vertical support loads A and B is 2500 kg, and the maximum moment result that is obtained is -612500 kg.mm.

Acknowledgements

Special thanks to Lembaga Penelitian dan Pengabdian kepada Masyarakat Universitas Islam Riau (LPPM UIR) for financing this research and also to Faculty of Engineering UIR for supporting and facilitating our research.

References

- Astika, IM., Negara, DNKP, Susantika, MA. 2010. Pengaruh jenis pasir cetak dengan zat pengikat bentonit terhadap sifat permeabilitas dan kekuatan tekan basah cetakan pasir (sand casting). *Jurnal Ilmiah Teknik Mesin*, Fakultas Teknik Universitas Udayana, 4(2), 132–138.
- Bechelany, M., Brioude, A., Bernard, S., Ferro, G., Cornu, D., Miele, P. 2007. Large scale preparation of faceted silicon nitride nanorods from beta silicon carbide nanowires. *Nanotechnology*, Vol. 18, pp. 1-6
- Chandran, V. G. and Waigaonkar, S. D. 2017. Rotational molding of linear low density polyethylene (LLDPE) fumed silica nanocomposites. *International Polymer Processing*, 32(1), 50–57.
- Chaudhari, M.G., Ahmadullah, S.K., Dey, R., Das, G. C., Mukherjee, S. and Mitra, M.K. 2011. Novel techniques for synthesis of silicon nitride nanowires. *Advances in Applied Ceramics*. Vol. 110, No. 4, pp. 211-214.
- Fadli, H., Dedikarni, Yulianto, D. 2021. Pengaruh penekanan pellet silika terhadap porositas dan permeabilitas. *Journal of Renewable Energy and Mechanics*, Vol. 4 (1), pp 1-6.
- Kou, X., He, Y., Li, Y., Chen, X., Feng, Y. and Xue, Z. 2019. Effect of abscisic acid (ABA) and chitosan/nanosilica/sodium alginate composite film on the color development and quality of postharvest chinese winter jujube (*Zizyphus jujuba* mill. cv. Dongzao). *Food Chem.* 270 385–394.
- Lashkaripour, G.R. and Ajalloeian, R. 2003. Determination of silica sand stiffness. *Engineering Geology*. Vol. 68(3), 225-236
- Latif, C., Triwikantoro, Munasir. 2014. Pengaruh variasi temperatur kalsinasi pada struktur silika. *Jurnal Sains dan Seni Pomits*, 4-7. doi:10.12962/j23373520.v3i1.5563.
- Shi, S.Y., Wang, W., Liu, L.Q., Wu, S.J., Wei, Y.Z. and Li, W.C. 2013. Effect of chitosan/nanosilica coating on the physicochemical characteristics of longan fruit under ambient temperature. *J. Food Eng.* 118 125–131.
- Sun, T., Wu, C.L., Hao, H., Dai, Y. and Li, J.R. 2016. Preparation and preservation properties of the chitosan coatings modified with the in situ synthesized nano SiO_x. *Food Hydrocoll.* 54 130–138.
- Thiel, J. 2011. Thermal expansion of chemically bonded silica sands. *AFS Transactions*, Vol. 116, pp. 369-378.
- Tie, S.N., Jiang, Z.Y. and Wang, C.G. 2012. The application research and present development situation of silica fume powder produced from submerged arc furnace smelting ferroalloy. *B. Chin. Ceram. Soc.* 31 1491–1497
- Yang, S., Luo, S., Huang, A., Luo, Y., Li, D., Wu, Y., and Ji, N. 2019. Mold resistance of bamboo treated with copper complexes-grafted silica gel and its microdistribution in treated bamboo. *Journal of Wood Science*, 65(1).
- Youssef, K., de Oliveira, A.G., Tischer, C.A., Hussain, I. and Roberto, S.R. 2019. Synergistic effect of a novel chitosan/silica nanocomposites-based formulation against gray mold of table grapes and its possible mode of action, *Int.J. Biol. Macromol.* 141 247–258.
- Youssef, K., and Roberto, S. R. 2021. Chitosan/silica nanocomposite-based formulation alleviated gray mold through stimulation of the antioxidant system in table grapes. *International Journal of Biological Macromolecules*, 168, 242–250
- Zainal et al., 2018. Pengaruh pembebanan tekan terhadap kekuatan material komposit diperkuat pengaruh pembebanan tekan terhadap kekuatan material komposit diperkuat serat ampas tebu. ISSN 2356-5438, 9(July), 5. <https://doi.org/ISSN 2356-5438>.