

# Oil Monitoring

*by* Evizal Evizal

---

**Submission date:** 24-Jan-2024 12:02PM (UTC+0700)

**Submission ID:** 2277247632

**File name:** nitoring\_System\_Based\_on\_IoT\_Technology\_and\_Machine\_Learning.pdf (699.42K)

**Word count:** 3778

**Character count:** 18836

# Oil Well Monitoring System Based on IoT Technology and Machine Learning

8

Evizal Abdul Kadir  
Department of Informatics Engineering  
Universitas Islam Riau  
Pekanbaru, 28284 Indonesia  
evizal@eng.uir.ac.id

Agus Arsad  
UTM-MPRC Institute for Oil and Gas  
Universiti Teknologi Malaysia  
Johor Bahru, 81310 Malaysia  
agus@utm.my

5

Muslim Abdurrahman  
Department of Petroleum Engineering  
Universitas Islam Riau  
Pekanbaru, 28284 Indonesia  
muslim@eng.uir.ac.id

Sri Listia Rosa  
Department of Informatics Engineering  
Universitas Islam Riau  
Pekanbaru, 28284 Indonesia  
srlistiarosa@eng.uir.ac.id

4

Sharul Kamal Abdul Rahim  
Wireless Communication Centre  
Universiti Teknologi Malaysia  
Johor Bahru, 81310 Malaysia  
sharulkamal@fke.utm.my

Apri Siswanto  
Department of Informatics Engineering  
Universitas Islam Riau  
Pekanbaru, 28284 Indonesia  
aprisiswanto@eng.uir.ac.id

**Abstract** — The process of crude oil mining in oil wells takes a long time and requires good supervision to avoid unwanted things. This process requires full 24-hours monitoring of oil parameters such as oil temperature and flow rate. Currently, the supervision process is still done manually which may occur some errors. Based on this fact, this paper aims to design a surveillance or monitoring system that is more effective and efficient. The testing of this monitoring system uses an oil pump machine prototype with the assistance of a MAX-6675 temperature sensor and an ultrasonic flowmeter TUF-2000m as well as a sensor TM-1 transducer as an input tool. Raspberry Pi 3 as a microcontroller and a web application as an output that displays data in the form of graphs. The test stage is carried out by heating the temperature sensor, slowing down the flow of oil on the prototype, and checking the values displayed on the graph. The results of the test when the temperature sensor received heat, the microcontroller ran well, as evidenced by the data that was successfully stored on the web server and a graph showing the increase in the oil temperature value. Likewise with the flow rate sensor when it receives resistance or the flow is slowed down, the graph shows a decrease in the flow rate value in the oil. With the results of this test, the prototype of the monitoring system on oil wells with the Internet of Things (IoT) technology runs as expected, namely being able to monitor the value of oil parameters in real-time which allows effectiveness and efficiency in work to increase.

**Keywords**—Oil Well, Monitoring System, Internet of Things

## I. INTRODUCTION

Energy is an important part of human life, without enough energy economic activity will slow down. Most of the energy used by humans comes from fossils, one of which is crude oil. This oil has been separated from natural gas after the extraction or mining process because crude oil is found together with natural gas [1]. Crude oil is a non-renewable natural resource, in the form of a dark brown or dark brown liquid or it can be greenish and has several very complex carbon chains, therefore crude oil is of high economic value. Data based on the central statistics agency shows that crude oil production in Indonesia in 2020 reached 259 million barrels [2]. Meanwhile, crude oil reserves reached 4.17 billion barrels. This figure certainly illustrates that the production of crude oil and natural gas in Indonesia is still very large. However, the oil reserve does not mean that it can be obtained

easily, the process of extracting oil from oil wells requires a systematic process and design of tools, starting from the design of pipes, pumps, and monitoring sensors that are very necessary. The process of extracting crude oil or fluids from production wells (oil wells) through a piping system is carried out in two ways, namely by using the individual system, flow line or by using a production line system is pumped to the Gathering Station (GS), the type of equipment used in the GS is generally largely determined by the parameters of temperature, pressure, and the resulting fluid.

Several works have been done the previous research related to the oil well monitoring system in a petroleum company, especially in the downstream process. Research on the monitoring of oil parameters and indicators for example liquid flow rate in the pipeline as discussed in [3-7]. The research monitors for a parameter and then sends the information to a database at the data center. While other research is to monitor oil well parameters using an ultrasonic sensor to find the values of flow and water content as elaborate in the [8-10], the discussion the how much sensitivity in the sensor to various sample pipeline sizes. The size and thickness of the pipe affected the sensitivity and reading of the sensor to the actual flow rate, a calibration in measurement and testing is required to achieve actual values. In the [11-12] discussion on monitoring water content in a pipeline near to oil well, the research to find how much water percentage in a well then, the percentage of oil from the pump at the oil well. While [13-14] elaborates on the flow sensing system to detect and monitor abnormality in a pipeline at the oil well. The discussion of the oil well monitoring system to retrieve well information for example pump status, voltage, current, and flow as well as the temperature as discussed in the [15-16].

This research aims to design a new model of a monitoring system for oil wells using IoT and store all the well data and information in a cloud system. Wireless monitoring systems apply to get the information that is a constraint for the remote location of the well. The proposed monitoring system has a new design with several sensor connected to each other's then sending all the information to the backend system for analysis as well as displaying the information on the command center.

## II. MONITORING AND SYSTEM DESIGN

Currently, the monitoring system on the oil well is running on the conventional method in which every sensor installed in each pipe will be checked by the officer periodically or manually written to find out the value of the parameters generated by the crude oil extraction process, sometimes even checking is only done when a problem occurs that does not occur. wanted. Figure 1 shows the illustrated of the physical oil well on the field for pumping the oil from the ground.



Fig. 1. Illustrated of oil well on the field and parts to monitor

### A. Conventional Oil Well Monitoring System

The value of the oil well parameter will determine various things such as production level, pipe safety, and so on. Based on the analysis of the current system, the following is an overview of the current system analysis. Figure 2 shows a conventional method of monitoring oil wells by directly visiting the site and recording manually on the sheet. Several instruments are installed on the oil well to monitor performance and production of the well, there are important parts to monitor such as temperature, flowrate, pump status, pressure including power supply which voltage and current supplied to well.

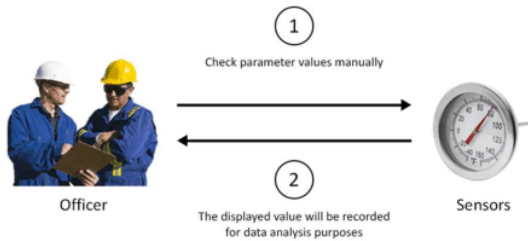

Fig. 2. Conventional monitoring of oil well

### B. Digital Oil Well Monitoring System

The proposed new method is to monitor the oil well indicator by digitalizing the system by installing the sensor to all the equipment and parameter would like to check and measure. The procedure analysis of this system is necessary to know the current procedures for designing the new system. Figure 3 shows the design of the following is an overview of the current system and proposed digital system for the oil well.

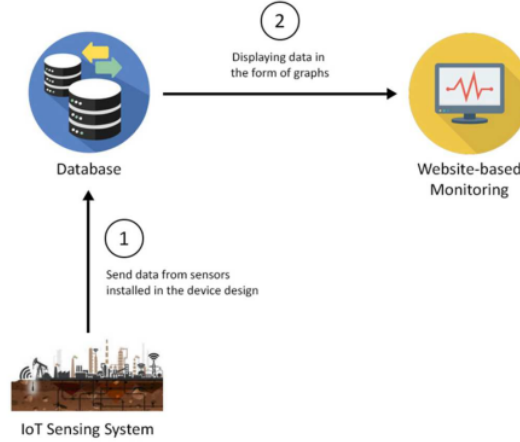

Fig. 3. Architecture of monitoring sytem in oil well

The use of an oil pump for the engine and prototype has many advantages, including minimizing the risk of accidents that could occur in the actual oil well area. In addition, by using a prototype, trials can be freely carried out many times and are not limited in time. The prototype that will be used is available in-house in the Laboratory, Faculty of Engineering, Islamic University of Riau. In this research, an ultrasonic flow meter model TUF-2000M was used with the help of a transducer model TM-1 which was installed with the method installation method. This sensor is installed on the outside of the pipe which is placed after the pump, and the temperature sensor used is the MAX-6675 sensor, installed into the pipe to read the temperature of the oil that is flowing. Here is the photo. Figure 4 shows the prototype of the oil well monitoring system while figuring 4(a) the full unit with a circulating pump system and figure 4(b) the sensor used in the prototype system for monitoring temperature and flow rate. The prototype can run as scenarios that we trying to simulate according to the actual operation on the field.



(a)



Fig. 4. Prototype of oil well monitoring system (a) the full unit of oil well with the circulate pump (b) sensor used in the prototype

The Raspberry Pi 4 microcontroller is needed in the initial data processing, its function is to receive data from sensors and forward it to the web server. The microcontroller sends data to the web server using a post request technique using the HTTP request library. The tool used and simulation has been done in the laboratory to check and monitor the system in a few days. Figure 5 shows a block diagram of the system and Raspberry Pi 4 microcontroller module used in this prototype of a system.

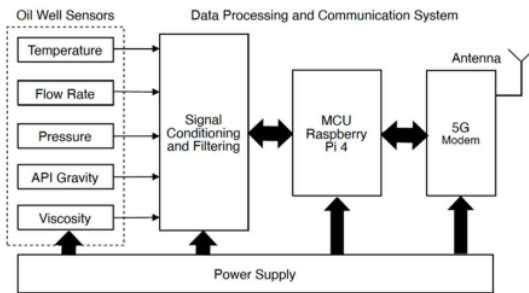

Fig. 5. Block diagram of monitoring system in oil well

System workflow design is a step-by-step process of describing how to sample test data sent within the system. And to produce oil, many processes are carried out and take a very long time, one of the processes is the extraction or mining process of oil, the results of which will be pumped into the GS through gathering pipes, and to find out how it works, a workflow design is made. The system workflow starts by checking the sensor and reading raw data using the flowrate sensor, this data will then be sent to the Raspberry Pi 3 microcontroller. After the data is received, the microcontroller will then check whether there is internet access, if there is data will be sent directly to the web server, else the data will be stored in the local database. All data stored in the local database will be sent to the web server when the microcontroller is connected to the internet. Figure 6 shows a flowchart of the entire monitoring process of the oil well in the field. All the data is stored in a database for accessing by the system in anytime at anywhere by pushing the data to a cloud computing.

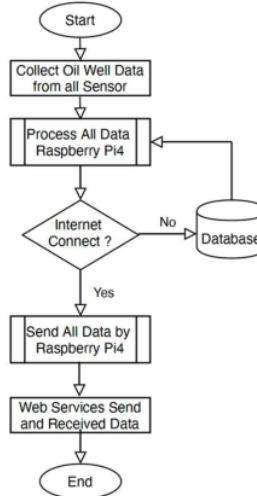

Fig. 6. Flowchart of the process of oil well monitoring

### C. LSTM Algorithm

The proposed method is different compared to other techniques as discussed previously, in that the LSTM deep learning algorithm applied with a big number of training data and testing data achieves high accuracy forecasting results for the specific case in the Indonesia region. Python programming is used in simulation and analysis as it is one of the high-level programs with a fast process, and it is applied in many kinds of deep learning algorithms. Figure 7 shows the structure of the RNN of the LSTM Algorithm.

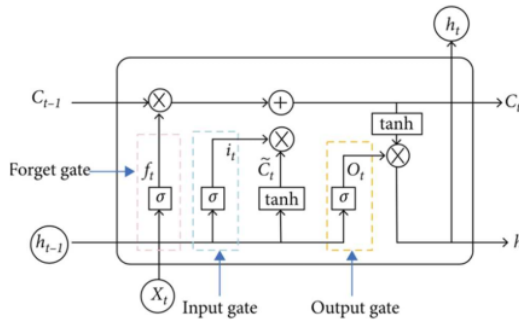

Fig. 7. Structure of the RNN-LSTM Algorithm

LSTM is divided in to two parts of the RNN's hidden state memory cell which are  $C_t$  and the  $h_t$  working memory. These memory cells are responsible for the retention of sequence features. The memory of the previous sequence is controlled by the forgetting gate  $f$  working memory, and  $h_t$  is used as output, and the output gate  $O$  controls the portion of  $C_t$  current memory  $C_t$  to be written as an input,  $i$  controls the portion of the current state information  $h_{t-1}$  and the current input  $X_t$  to be written to the memory cell. The three types of gates above are not static. The previous state information  $h_{t-1}$

and the current input  $X_t$  are determined together through nonlinear activation after linear combination. The LSTM model consists of three major cells, and each cell can be written as Equations (1)–(6).

$$f_t = \sigma(W_f \cdot [h_{t-1}, x_t] + b_f) \quad (1)$$

$$i_t = \sigma(W_i \cdot [h_{t-1}, x_t] + b_i) \quad (2)$$

$$\tilde{C}_t = \tanh(W_c \cdot [h_{t-1}, x_t] + b_c) \quad (3)$$

$$C_t = f_t * C_{t-1} + i_t * \tilde{C}_t \quad (4)$$

$$o_t = \sigma(W_o [h_{t-1}, x_t] + b_o) \quad (5)$$

$$h_t = o_t * \tanh(C_t) \quad (6)$$

where  $w_i$ ,  $w_c$ , and  $w_o$  are weight matrixes of  $b_f$ ,  $b_i$ ,  $b_c$ , and  $b_o$  are bias vectors,  $\tilde{C}_t$  is the new candidate state generated by  $x_t$  and  $h_{t-1}$  through the *tanh* layer, and  $\sigma$  is the sigmoid activation function.

Figure 8 shows a complete prototype oil well system, while several sensors are embedded in the system to obtain actual data from the well. The prototype can demonstrate how the actual process in the well as the representative of the actual well in the site.

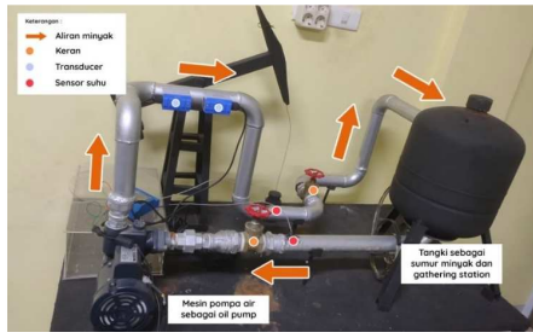

Fig. 8. Complete prototype of oil well monitoring system with process flow

### III. RESULTS AND DISCUSSION

The results of the design of an oil well monitoring tool with the Internet of Things are as shown in figure 7 with the complete circulation system for testing in various scenarios as actual on the field. Testing of the temperature sensor will be tested with four tests, the first test is by heating the pipe using wax as a heat generator and the second test turning off the heater and letting the temperature or temperature of the oil drop, and the third and fourth tests are the same as the first test, only the test is not too hot so that there is the resulting difference.

According to figure 9, it can be seen that the sensor is attached to the frame. The temperature sensor (red point) is located before and after the pump engine, the flowmeter using

a transducer (blue point) is located after the pump engine, and the faucet (orange point) is located before and after the pump engine. Please note, when oil is sucked in by the pump, the tank is considered an oil well and when it has passed through the pump, the tank is considered a gathering station. The process of oil flow in this prototype is that the Oil pump (pump engine) will suck oil from the oil well (tank) so that the oil flows through the oil pump and then the oil will continue to flow until it enters the gathering station (tank). Figure 8 shows an interface of the oil well monitoring system for the temperature and flowrate measurement.

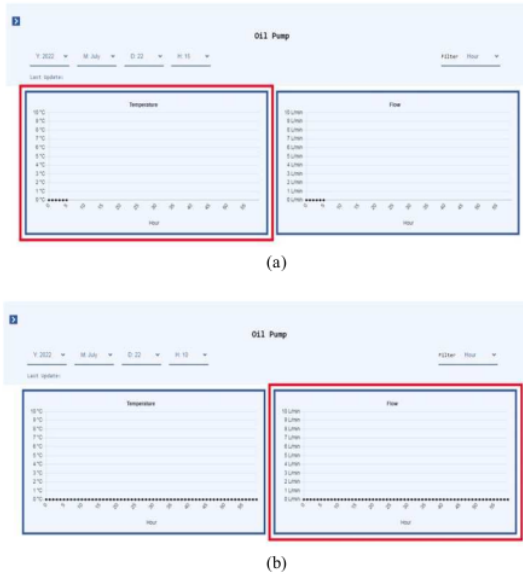
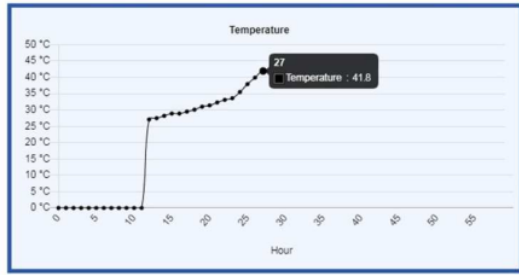
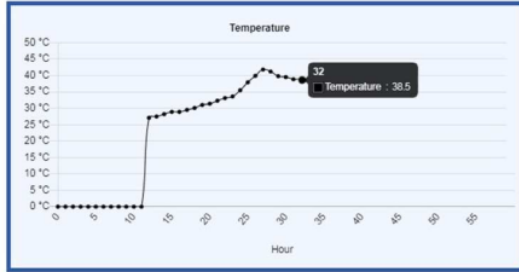

Fig. 9. Sample of graphs as display in monitoring system

Based on this process, the function of the first temperature sensor is to check the temperature of the oil before it is mined, the value of this sensor is only for testing the tool and the oil itself. The value that will be taken for monitoring is the value of the second temperature sensor, the sensor located after passing the oil pump. The function of the flowmeter sensor is to take the flow rate value of the oil that flows after passing through the pump engine, and the faucet function to test the flow rate value when there is an obstacle. Then finally, the results of the oil well monitoring web design are shown below. The results of the temperature sensor test will be displayed in graphical form in a monitoring web application. The graphic display can be seen in the image as shown in figure 10 (a), (b), and (c) for scenarios of temperature.



(a)



(b)

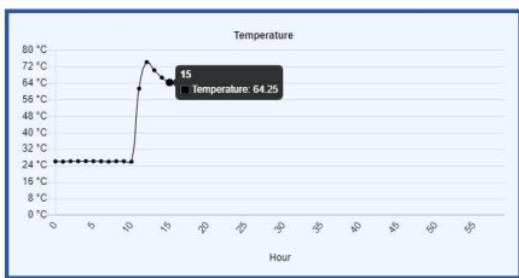

(c)

Fig. 10. Monitoring of oil well temperature in various scenarios (a) temperature 41.8 (b) temperature 38.5 degree (c) temperature 64.25 degree

While the flow rate sensor of the oil well and distribution pipe to the GS is measured in single line flow, the process is to monitor and retrieve sample data flow with duration every minute. Figure 11 (a), (b), and (c) shows a display of the measurement of flowrate in a pipe which is 0.23, 8.43, and 0.52 liters/minute, for the oil well monitoring system. This standard in the prototype unit is in unit liters/minute but in the actual field, the unit may be high liters/second or in oil barrels. The results of measurement flowrate to check and in actual situation to confirmation of the oil well is working fine to produce oil or the oil pump is working to supply oil to GS. Oil flow rate in a pipeline has an impact and indicator of the oil production, the normal flowrate has standard and may be different in every well, by the record and check the normality the production or failure of a well identified by the monitoring system. Current status of

parameters be able to monitor in a prototype are temperature and flow rate as shows in figure 10 and 11. While the other parameters such as API, Viscosity, and pressure of crude oil in the pipeline still under conducting the research and will added to the prototype system once completed.

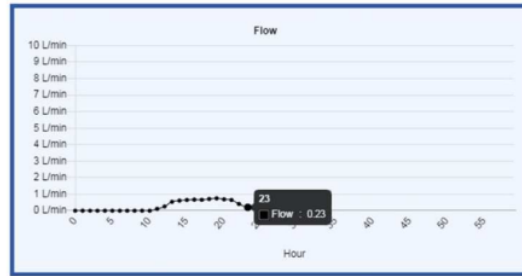

(a)

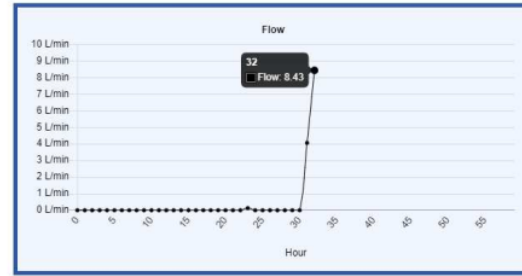

(b)

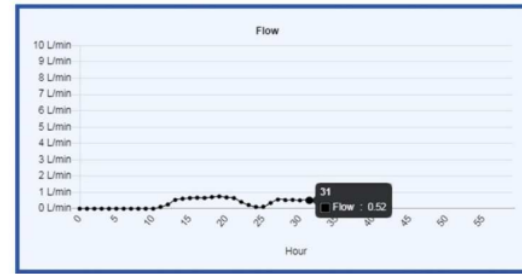

(c)

Fig. 11. Monitoring system of pipeline flowrate in an oil well (a) 0.23 (b) 8.43 (c) 0.53 liters/minute

#### IV. CONCLUSION

This research aims to monitor oil well status and equipment installed, the processes of designing, manufacturing, testing, and discussing oil well monitoring tools, it can be concluded several things such as an IoT-based oil well monitoring prototype was made using a Raspberry Pi 4 microcontroller with the help of a TUF-2000M flowrate sensor and a temperature sensor connected to a Web server. The process of monitoring temperature and flowmeter using the Raspberry Pi 4 as a bridge between the TUF-2000M sensor and the Web server. Data from the flowrate and temperature sensors are sent using the request post technique and

successfully display by the web system. The future development of the system is to do parallel monitoring for numbers of oil well that achieve real-time monitoring concurrently to all well.

6

#### ACKNOWLEDGEMENT

We would like to express our gratitude to the Ministry of Education, Culture, Research and Technology of Indonesia for funding the research, Universiti Teknologi Malaysia, and Universitas Islam Riau, Indonesia for research facilities as matching grant collaboration.

#### REFERENCES

- [1] Kesoema, Widhowati., Sulistiyaning, Harmin., "Studi Literatur Alternatif Penanganan Tumpahan Minyak Mentah Menggunakan Bacillus subtilis dan Pseudomonas putida (Studi Kasus: Tumpahan Minyak Mentah Sumur YYA-1)", Jurnal Teknik ITS, Vol.9, 2020.
- [2] Mustaghfirin, "Proses Produksi Migas, Kementerian Pendidikan dan Kebudayaan", 2013.
- [3] D. Wang, R. He, J. Han, M. Fattouche and F. M. Ghannouchi, "Sensor network-based oilwell health monitoring and intelligent control", IEEE Sensors J., vol. 12, no. 5, pp. 1326-1339, May 2012.
- [4] C. Tan, N. N. Wang, and F. Dong, "Oil-water two-phase flow pattern analysis with ERT based measurement and multivariate maximum Lyapunov exponent," J. Cent. South Univ., vol. 23, no. 1, pp. 240-248, Jan. 2016, doi: 10.1007/s11771-016-3067-3.
- [5] E. A. Kadir, A. Efendi, and S. L. Rosa, "Application of LoRa WAN Sensor and IoT for Environmental Monitoring in Riau Province Indonesia," in 2018 5th International Conference on Electrical Engineering, Computer Science and Informatics (EECSI), 16-18 Oct. 2018 2018, pp. 281-285, doi: 10.1109/EECSI.2018.8752830.
- [6] G. Yang, Z. Ma, W. Xu, X. Huang and J. Zhou, "The development of drilling engineering monitoring system using wireless sensor networks", Przegląd Elektrotech., vol. 89, no. 1, pp. 37-40, 2013.
- [7] E. A. Kadir, S. M. Shamsuddin, S. Hasan, and S. L. Rosa, "Wireless monitoring for big data center server room and equipments," in 2015 International Conference on Science in Information Technology (ICSITech), 27-28 Oct. 2015 2015, pp. 187-191, doi: 10.1109/ICSITech.2015.7407801.
- [8] M. M. F. Figueiredo, J. L. Goncalves, A. M. V. Nakashima, A. M. F. Fileti, and R. D. M. Carvalho, "The use of an ultrasonic technique and neural networks for identification of the flow pattern and measurement of the gas volume fraction in multiphase flows," Experiment. Thermal Fluid Sci., vol. 70, pp. 29-50, 2016.
- [9] E. A. Kadir, H. Irie, S. L. Rosa, B. Saad, S. K. A. Rahim, and M. Othman, "Remote Monitoring of River Water Pollution Using Multiple Sensor System of WSNs and IoT," in Sensor Networks and Signal Processing, Singapore, S.-L. Peng, M. N. Favorskaya, and H.-C. Chao, Eds., 2021// 2021: Springer Singapore, pp. 99-113.
- [10] H. J. Park, Y. Tasaka, and Y. Murai, "Ultrasonic pulse echography for bubbles traveling in the proximity of a wall," Meas. Sci. Technol., vol. 26, no. 12, p. 125301, 2015.
- [11] C. Zhao, G. Wu, and Y. Li, "Measurement of water content of oil-water two-phase flows using dual-frequency microwave method in combination with deep neural network," Measurement, vol. 131, pp. 92-99, Jan. 2019, doi: 10.1016/j.measurement.2018.08.028.
- [12] E. A. Kadir, H. Irie, and S. L. Rosa, "Modeling of Wireless Sensor Networks for Detection Land and Forest Fire Hotspot," in 2019 International Conference on Electronics, Information, and Communication (ICEIC), 22-25 Jan. 2019 2019, pp. 1-5, doi: 10.23919/ELINFOCOM.2019.8706364.
- [13] P. Angeli and G. F. Hewitt, "Flow structure in horizontal oil-water flow," Int. J. Multiphase Flow, vol. 26, pp. 1117-1140, Jul. 2000, doi: 10.1016/S0301-9322(99)00081-6.
- [14] E. A. Kadir, M. Othman, and S. L. Rosa, "Smart Sensor System for Detection and Forecasting Forest Fire Hotspot in Riau Province Indonesia," in 2021 International Congress of Advanced Technology and Engineering (ICOTEN), 4-5 July 2021 2021, pp. 1-6, doi: 10.1109/ICOTEN52080.2021.9493535.
- [15] T. Nakashima, T. Shiratori, Y. Murai, Y. Tasaka, Y. Takeda, and E. J. Windhab, "Viscoelastic responses of flow driven by a permeable disk investigated by ultrasound velocimetry pro ling," Flow Meas. Instrument., vol. 48, pp. 97-103, Apr. 2016.
- [16] E. A. Kadir, S. L. Rosa, and R. A. Ramadhan3, "Detection of Forest Fire Used Multi Sensors System for Peatland Area in Riau Province," in 6th International Conference on Industrial Mechanical Electrical Chemical Engineering 2020, Surakarta, Indonesia, W. Sutopo, Ed., 2020: AIP Conference Proceedings

# Oil Monitoring

---

## ORIGINALITY REPORT

---

10%

SIMILARITY INDEX

9%

INTERNET SOURCES

8%

PUBLICATIONS

8%

STUDENT PAPERS

---

## PRIMARY SOURCES

---

1	<a href="https://openresearch-repository.anu.edu.au">openresearch-repository.anu.edu.au</a> Internet Source	3%
2	Yunjun Yu, Junfei Cao, Jianyong Zhu. "An LSTM Short-Term Solar Irradiance Forecasting Under Complicated Weather Conditions", IEEE Access, 2019 Publication	2%
3	<a href="http://www.zbw.eu">www.zbw.eu</a> Internet Source	1%
4	Evizal Abdul Kadir, Raed Shubair, Sharul Kamal Abdul Rahim, Mohamed Himdi, Muhammad Ramlee Kamarudin, Sri Listia Rosa. "B5G and 6G: Next Generation Wireless Communications Technologies, Demand and Challenges", 2021 International Congress of Advanced Technology and Engineering (ICOTEN), 2021 Publication	1%
5	Submitted to Universitas Siswa Bangsa Internasional Student Paper	1%

---



6

[eprints.gla.ac.uk](http://eprints.gla.ac.uk)

Internet Source

1 %

---

7

[repository.unsri.ac.id](http://repository.unsri.ac.id)

Internet Source

1 %

---

8

[www.scribd.com](http://www.scribd.com)

Internet Source

1 %

---

Exclude quotes  On

Exclude matches  < 1%

Exclude bibliography  On