

IJEECS

by Evizal Evizal

Submission date: 24-Jan-2024 11:39AM (UTC+0700)

Submission ID: 2277228115

File name: IJEECS_article.pdf (536.45K)

Word count: 4422

Character count: 24710

Biometric face authentication system for secure smart office environments

Apri Siswanto, Akmar Efendi, Evizal Abdul Kadir

Department of Informatics Engineering, Faculty of Engineering, Universitas Islam Riau, Riau, Indonesia

Article Info

Article history:

Received Jul 4, 2023

Revised Aug 3, 2023

Accepted Aug 7, 2023

Keywords:

Authentication

Biometric

Face

Sensor

Smart office

ABSTRACT

The use of the smart office concept in security has increased significantly recently. One of the areas of concern is the use of facial finger biometric technology for authentication systems, for example, authentication to enter a particular room in an office. This paper aims to describe a new prototype for office door automation and security that combines facial biometric technology and NodeMCU. Hopefully, this system will help increase the safety and comfort of office employees with easy installation and low cost. This system automatically controls (opens or closes) the door based on the biometrics of the user's face registered in the database on the NodeMCU microcontroller. The main system comprises a NodeMCU microcontroller, face sensors, and a door lock system.

This is an open access article under the [CC BY-SA](https://creativecommons.org/licenses/by-sa/4.0/) license.



Corresponding Author:

Apri Siswanto

Department of Informatics Engineering, Faculty of Engineering, Universitas Islam Riau

Street of Kaharuddin Nasution No. 113 Pekanbaru, Riau, Indonesia

Email: aprisiswanto@eng.uir.ac.id

1. INTRODUCTION

The current development of information and communication technology offers convenience to users from various walks of life. One of the technologies currently being developed is smart office technology [1], [2]. The concept of a smart office is getting real, along with the increasing number of work activities integrated with digital technology and the internet. In simple terms, smart office is a collaboration of smart technology and the internet of things (IoT) implemented in a work environment. Smart office deployments help employees work smarter, better, and faster. In addition, the technology contained in smart office also helps businesses maintain spending efficiency and asset security. The technology embedded in this smart office usually includes building technology, security, front desk, meeting rooms, and other technologies [3]–[5].

A smart office is a combined system of technology and services specialized in office convenience with functions aimed at increasing efficiency, and security for owners and employees [6]. A smart office is an environment with information and communication technology that can support work by means of efficiency and social interaction functions [7] according to Shorten and Khoshgoftaar [3] revealed, there are four advantages of a smart office that the office industry inevitably has to pay attention to, namely: "1) smart office educates workers; 2) smart office is a highly integrated ecosystem; 3) smart office supports remote work; 4) smart office keeps workers safe. Access control and authentication, security, asset monitoring and protection, environmental management, energy-saving products, entertainment and audio distribution, home control, lighting, and appliance control are a few areas where smart office development is concentrated. Then a smart office can be considered as a super system of subsystems that are interconnected with buildings [8]. Smart office requires connectivity all systems and equipment in a building. This helps leaders to visualize information and make quick and correct decisions. Smart office is created using various strategies. Through building

automation or building management systems, automatic centralized control of various building sub-systems, namely lighting, air temperature control, ventilation and air conditioning, and other systems [9]. The goal of a building automation system is to increase the efficient operation of the building management system, occupant comfort, and reduce energy consumption and operating costs, as well as increase the utility life cycle [10]. In the research of Siswanto, Wu *et al.* [11] they proposed a simple IoT-based home security system implemented using fingerprint biometric technology. This system is demonstrated using a prototype consisting of hardware and software components. The hardware includes a fingerprint sensor, microcontroller, wireless network router, application server, and smartphone. All components connect to the home network wirelessly, making the system easier to implement at a lower cost. Mosavi *et al.* [12], they designed a light and fan control system automatically based on the intensity of sunlight. This research has successfully proposed low-cost and user-friendly energy saving in smart offices. This aligns with research by Palanisamy and Thirunavukarasu [13], who designed an application that can help everyone control and monitor the use of home lights remotely using only a smartphone connected to the internet. This application uses the help of a microcontroller as a tool that can control electrical switches connected to mini servers connected to the network.

Furthermore, Sadowski [14], proposed an IoT-based smart model for smart offices. This can help provide an effective work environment by focusing on two aspects. The first aspect is to remotely control all the devices in the office with a smartphone. The second and third aspects are increased security and safety. Furthermore, in Saura *et al.* [15] presented a smart monitoring and control automation system using remote technology (LoRa). The proposed LoRa-based system consists of a wireless communication system and various types of sensors, operated by a smartphone app and powered by a low-power battery, with an operating range of 3-12 km. The system connects the android phone and the microprocessor (ESP32) via Wi-Fi on the sending end. The ESP32 module is connected to the LoRa module. At the receiving end, ESP32 modules and LoRa modules without Wi-Fi were used. The study obtained correct environmental data, fire detection with 90% accuracy, and switching functionality with 91.3% accuracy at a distance of up to 12 km, demonstrating good system performance. The proposed system with a modular design has proven to be very effective in controlling and monitoring household appliances from a greater distance with relatively lower power consumption. Then in prentice's Nallaperuma *et al.* [16], Schulz *et al.* [17] developed and evaluated smart office applications.

Although many previous studies have designed security systems for smart offices based on the IoT, the current system still has several gaps that need better development. Recent and previous studies by other researchers have reported many studies applied in the smart office environment. However, to our knowledge, no specific work designs a smart office using node-mcu microcontroller-based facial sensors and sends data using a Wifi network. Designing a smart office authentication system using face sensors can help reduce virus transmission impact, such as using fingerprint sensors.

This paper describes the design of a smart office prototype for the security of office doors or certain room doors with face sensors and the NodeMCU microcontroller. In our daily lives, security is a fundamental concern, and digital locks have emerged as a crucial component of this security system. Smart offices can be secured with a wide variety of security technologies. Biometric systems, digital lock systems, RFID-based security systems, and electronic code locks are a few examples.

Currently, the biometric system is the choice for authentication systems. Biometric authentication comes from the greek word bios which means life and metron which means measure. then it can be interpreted as the study of automatic methods to recognize humans based on one or more parts of the human body or the behavior of the human himself have uniqueness. In the world of information technology, biometrics are relevant to technology that is used to analyze physical and human behavior for authentication. For example in human physical recognition, namely by recognizing fingerprints, retinas, irises, facial patterns (facial patterns), signature (signature), and how to type (keystroke) [18]–[20].

One of the most accurate biometric technologies is facial biometrics. Everyone has different shapes, structures, and facial expressions [21]. In addition, facial biometrics is the most accurate identification technology because the face is the part of the human body that is most easily recognized. This biometric technology works by analyzing and detecting the most accurate points on the face for identifying a person's identity [22], [23]. In the process of detecting facial characteristics, three levels of facial characteristics are detected. The are three levels of facial characteristics in facial biometric technology [24], [25]:

- Level 1, the characteristics of this level are the most easily observable characteristics of the face. Generally, at this level, the system will detect the shape of the face (geometry) and the color of the facial skin.
- Level 2, this characteristic detects a person's face from the facial structure. This facial structure is a component of the face, such as the nose, mouth, eyes, distance the eyes, and others.
- Level 3 is the micro level where the system will detect the most accurate point. this duck is part of the face that is not structured. For example, changes in skin color, scratches, facial skin texture, and others. This

5

Biometric face authentication system for secure smart office environments (Apri Siswanto)

biometric technology is often used as a security system. Not only that, but even in other countries this technology has been used to tackle crime. In fact, this technology has been used in Singapore as a primary identity, such as an identity card.

2. METHOD

This research is experimental. The main objective of this research is to design a facial recognition and biometric system for implementation in smart office environments. Then, evaluating the performance of the designed system is an important task that must be completed, as stated in the background of the research problem. To achieve this goal, the design research methodology (DRM) was used for each stage of the research [26]. The DRM stages used in this study consist of problem awareness, suggestion, development, evaluation, and conclusion.

Problem awareness and suggestions as two related steps in the general methodology of DRM were carried out in the first phase of the research. Awareness of previous research and research in smart office and biometric authentication has resulted in a good knowledge of research gaps and opportunities. It has been used as a basic research framework. The output of this step is a complete understanding of the basic design of automation and authentication systems in smart office environments and facial recognition biometric technology. Suggestions as a second step are related to investigations related to all the literature in automation and biometric authentication, especially in the smart office environment. The output of this stage is a tentative design which it describes the conceptual design of the proposed system. At the development stage, the output is a system prototype that includes technical design for monitoring, automation, and biometric authentication, especially in the IoT and smart office environments. The design of the prototype is as shown in Figure 1.

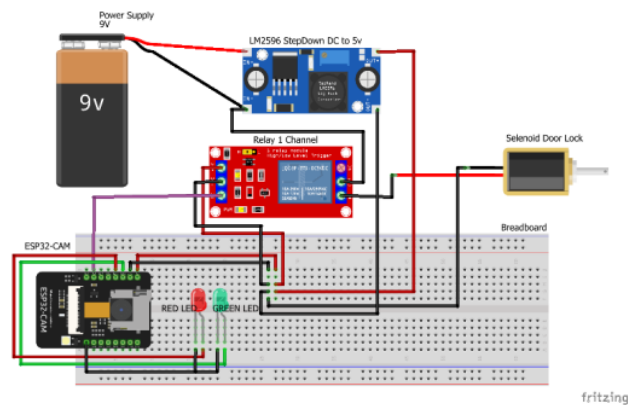

Figure 1. Hardware prototype design

The function of each component is described here:

- 1) Face sensor (ESP32 CAM) functions as a sensor that receives facial images. The sensor generates digital data to create facial biometric templates and stores the data in a database for the first time and an input device to authenticate facial biometrics later. facial recognition works by mapping the unique geometrical face of someone who has been registered. The facial geometry in question is the distance from the chin to the forehead, the distance the eyes, the length of the jawline.
- 2) The microcontroller board is the system's hub and manages all input and output activities. It takes data from facial sensors, and then processes it, stores it in memory, and communicates with the network.
- 3) The power supply functions to change the current voltage so that it does not exceed the maximum limit of the device. Then it becomes backup power in the form of a battery.
- 4) In this design, the relay functions as a switch (connector and circuit breaker) to operate the solenoid valve.
- 5) The water flow sensor requires a voltage of 5V, therefore, a step-down module is used to reduce the power supply voltage from 12V to 5V.
- 6) Solenoid door lock is an electronic device that can secure doors.

Evaluation is an important step in DRM that creates an important part of knowledge and lessons learned about the designed system and problem areas. The system is evaluated based on the proposed biometric authentication to measure whether it will achieve the performance and security that the user requires. The evaluation will involve mathematical and statistical data which ultimately supports the results and conclusions of the research. The last step is the conclusion. This step identifies research contributions and limitations and processes research reports future research.

This research intends to implement face authentication at the main door in a smart office environment. When this prototype is implemented in a smart office, an authorized employee is required to register his facial data with an application stored on the microcontroller. Employees scan their faces using the face sensor (ESP 32 cam). Scan results are stored in digital format in the microcontroller database. After that, the facial recordings are processed by generating a list of unique pattern features. The facial pattern feature is stored in the database. When employees scan their faces, the patterns generated from the faces will be matched with those stored in the database. If the two data match, then the microcontroller sends an approval signal to the switch to unlock the door and grant access to the employee. The flowchart in Figure 2 shows the process flow of the proposed system.

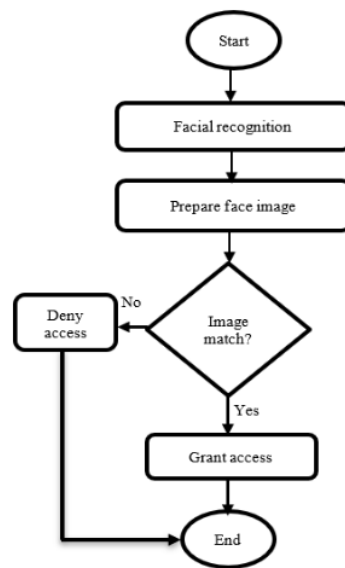

Figure 2. The process of prototype design

A client-side and server-side Algorithms 1-4 have been developed to show the basic authentication process. The process is divided into the enrolment and verification:

Algorithm 1. The client-side algorithm for the enrolment process

```

User scans face using face sensor (ESP 32CAM);
Capture face image;
Extract face image;
Create face template;
Send face template to the microcontroller server for enrolment;
  
```

Algorithm 2. The server-side algorithm for the enrolment process

```

Receive face template from sensor;
Store face template in the microcontroller database;
  
```

Algorithm 3. The client-side algorithm for the verification process

```

User scans face using sensor;
Capture face image;
Extract face image;
Create face template;
Send face template to the microcontroller server for verification;
  
```

Algorithm 4. The server-side algorithm for the verification process

```
Receive user face template from sensor;  
Compare user face template with existing data in the microcontroller database;  
if (user face templates match) {  
  open door;  
} else  
  display warning;  
}
```

3. RESULTS AND DISCUSSION

This study aims to apply facial sensors for authentication at the main office door or particular doors that are implemented in an intelligent office environment. When this system is implemented in a smart office, company employees are asked to register their facial data with a simple application. The data will be stored in the NodeMCU microcontroller memory.

There are several stages in identifying facial characteristics. The first stage is the acquisition of facial biometric images. In this first stage, the system will digitally acquire a facial image. This acquisition process uses a scan tool or sensor with an infrared heat scan. The second stage is facing detection. After the system gets an image of the face, this facial biometric system will detect the face's shape, color, structure, and texture. In fact, this detection is also carried out on facial expressions and poses in its development. At this stage, the system will detect many points that are believed to be the most valid points. The third stage is the process of feature extraction and face matching. The final stage of the facial recognition process in this biometric technology is extracting the facial features and performing the matching. The extraction and matching process is carried out using three approaches, namely appearance-based, model-based, and also texture-based. Of the three approaches, the texture-based approach is the most accurate. Figure 3 describes the configuration of biometric facial authentication using facial recognition biometrics. Hardware design is a design tool for building prototypes for smart office buildings.

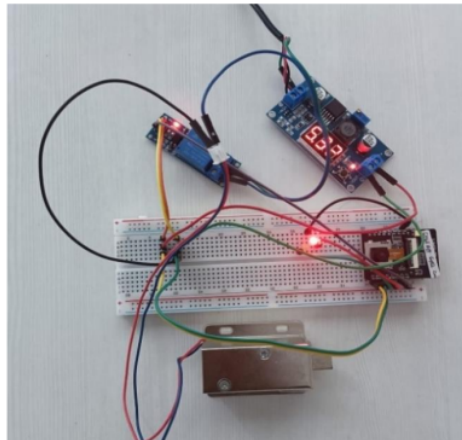

Figure 3. Hardware prototype design results

In the process of registering and authenticating user face biometrics, simple coding is made here from the Arduino IDE. A user must register his face so that it can be recognized in the NodeMCU microcontroller database. After being registered, the user will be allowed access to the prototype of the house that has been designed. Figure 4 shows the code from the face authentication and enrollment process for door locks in a smart office environment.

Figure 5 describes the process of recording facial data. First, the user must register the face of the finger. The first step is recording digital data, verifying that the recording process is complete and that converting fingerprint data into a digital template is successful. After successfully recording into the database, the registered digital facial templates can access the smart office environment. Figure 6 shows the authorized authentication process.

4

```

CameraFaceRecognitionDoorLock.ino  app_httpd.cpp  camera_index.h  camera_pins.h
1 //ESP Camera Artificial Intelligence Face Detection Automatic Door Lock
2 #include "esp_camera.h"
3 #include <WiFi.h>
4
5 //
6 // WARNING!!! Make sure that you have either selected ESP32 Wrover Module,
7 // or another board which has PSRAM enabled
8 //
9 //
10 // Select camera model
11 #define CAMERA_MODEL_WROVER_KIT
12 #define CAMERA_MODEL_ESP_EYE
13 #define CAMERA_MODEL_ESP32CAM_PSRAM
14 #define CAMERA_MODEL_ESP32CAM_WIDE
15 #define CAMERA_MODEL_AI_THINKER
16 #define Relay 2
17 #define Red 13
18 #define Green 12
19 #include "camera_pins.h"
20
21 const char* ssid = "Tp-Link X2YOU"; //WiFi Name SSID
22 const char* password = "satusatu8kali"; //WiFi Password
23
24 void startCameraServer()
    
```

Figure 4. Face recognition program code

Whereas for users who are not registered in the database, the system will automatically refuse to gain access to the smart office environment. This is one of the advantages of a biometric system where there is no reason to forget passwords or keys because everything can be done with biometric technology in both the physical category of the body and human behavior. For the identification information rejected by the system, it can be seen in Figure 6.

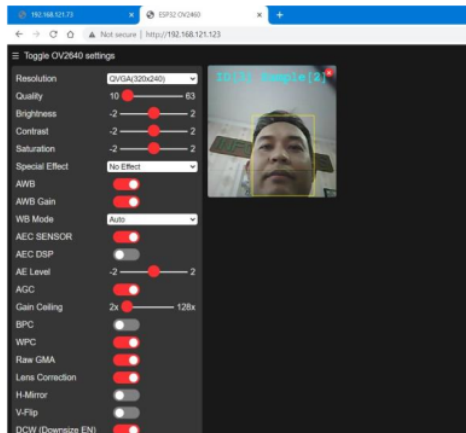

Figure 5. Authorized authentication process

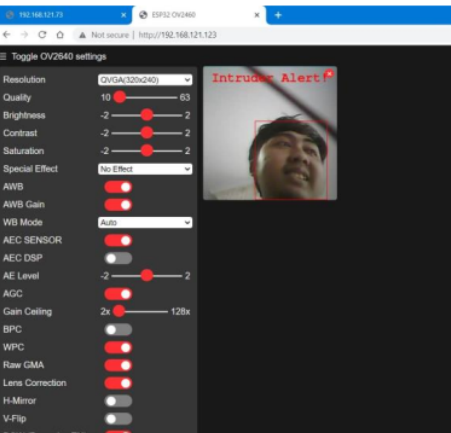

Figure 6. Denied authentication process

Based on the tests, this prototype can work well in recording data and authenticating registered users in the database. A facial identification biometric system provides a good solution for door security in a smart office environment. A new prototype of a cost-effective biometric facial identification technology is proposed in this paper. It gives a basic idea of integrating door lock, face sensor, NodeMCU microcontroller, and door

Biometric face authentication system for secure smart office environments (Apri Siswanto)

lock with a simple application. As a trend on biometric system security, this architecture will require implementation in real systems so that this system can provide better benefits. The future will be created for hardware and software design to see the capabilities of this system in secure smart offices. The author predicts this architecture is very economical.

4. CONCLUSION

The use of biometric fingerprints for door security systems in smart office environments using the NodeMCU microcontroller can be an alternative for reliable and low-cost smart office environment security. All the components used are relatively cheap and widely available in the market. It is expected that this system can provide functions similar to real systems for security in a smart office environment.

10

ACKNOWLEDGEMENTS

This research is supported by the directorate of research and community service, Universitas Islam Riau with internal research grant scheme (research contract number: 128/KONTRAK/P-PT/DPPM-UIR/07-2022).



REFERENCES

- [1] M. Sigala, A. Beer, L. Hodgson, and A. O'Connor, "Big data for measuring the impact of tourism economic development programmes: a process and quality criteria framework for using big data," in *Big Data and Innovation in Tourism, Travel, and Hospitality: Managerial Approaches, Techniques, and Applications*, Singapore: Springer Singapore, 2019, pp. 57–73.
- [2] G. Nguyen *et al.*, "Machine learning and deep learning frameworks and libraries for large-scale data mining: a survey," *Artificial Intelligence Review*, vol. 52, no. 1, pp. 77–124, Jun. 2019, doi: 10.1007/s10462-018-09679-z.
- [3] C. Shorten and T. M. Khoshgoftaar, "A survey on image data augmentation for deep learning," *Journal of Big Data*, vol. 6, no. 1, p. 60, Dec. 2019, doi: 10.1186/s40537-019-0197-0.
- [4] R. Vinayakumar, M. Alazab, K. P. Soman, P. Poornachandran, A. Al-Nemrat, and S. Venkatraman, "Deep learning approach for intelligent intrusion detection system," *IEEE Access*, vol. 7, pp. 41525–41550, 2019, doi: 10.1109/ACCESS.2019.2895334.
- [5] K. Sivaraman, R. M. V. Krishnan, B. Sundarraj, and S. S. Gowthem, "Network failure detection and diagnosis by analyzing syslog and SNS data: Applying big data analysis to network operations," *International Journal of Innovative Technology and Exploring Engineering*, vol. 8, no. 9 Special Issue 3, pp. 883–887, Aug. 2019, doi: 10.35940/ijitee.I3187.0789S319.
- [6] A. D. Dwivedi, G. Srivastava, S. Dhar, and R. Singh, "A decentralized privacy-preserving healthcare blockchain for IoT," *Sensors (Switzerland)*, vol. 19, no. 2, p. 326, Jan. 2019, doi: 10.3390/s19020326.
- [7] F. Al-Turjman, H. Zahmatkesh, and L. Mostarda, "Quantifying uncertainty in internet of medical things and big-data services using intelligence and deep learning," *IEEE Access*, vol. 7, pp. 115749–115759, 2019, doi: 10.1109/ACCESS.2019.2931637.
- [8] S. Kumar and M. Singh, "Big data analytics for healthcare industry: impact, applications, and tools," *Big Data Mining and Analytics*, vol. 2, no. 1, pp. 48–57, Mar. 2019, doi: 10.26599/BDMA.2018.9020031.
- [9] L. M. Ang, K. P. Seng, G. K. Ijemanu, and A. M. Zungeru, "Deployment of IoT for smart cities: applications, architecture, and challenges," *IEEE Access*, vol. 7, pp. 6473–6492, 2019, doi: 10.1109/ACCESS.2018.2887076.
- [10] B. P. L. Lau *et al.*, "A survey of data fusion in smart city applications," *Information Fusion*, vol. 52, pp. 357–374, Dec. 2019, doi: 10.1016/j.inffus.2019.05.004.
- [11] Y. Wu *et al.*, "Large scale incremental learning," in *Proceedings of the IEEE Computer Society Conference on Computer Vision and Pattern Recognition*, Jun. 2019, vol. 2019-June, pp. 374–382, doi: 10.1109/CVPR.2019.00046.
- [12] A. Mosavi, S. Shamshirband, E. Salwana, K. Wing Chau, and J. H. M. Tah, "Prediction of multi-inputs bubble column reactor using a novel hybrid model of computational fluid dynamics and machine learning," *Engineering Applications of Computational Fluid Mechanics*, vol. 13, no. 1, pp. 482–492, Jan. 2019, doi: 10.1080/19942060.2019.1613448.
- [13] V. Palanisamy and R. Thirunavukarasu, "Implications of big data analytics in developing healthcare frameworks – A review," *Journal of King Saud University - Computer and Information Sciences*, vol. 31, no. 4, pp. 415–425, Oct. 2019, doi: 10.1016/j.jksuci.2017.12.007.
- [14] J. Sadowski, "When data is capital: datafication, accumulation, and extraction," *Big Data and Society*, vol. 6, no. 1, p. 205395171882054, Jan. 2019, doi: 10.1177/2053951718820549.
- [15] J. R. Saura, B. R. Herraiz, and A. Reyes-Menendez, "Comparing a traditional approach for financial brand communication analysis with a big data analytics technique," *IEEE Access*, vol. 7, pp. 37100–37108, 2019, doi: 10.1109/ACCESS.2019.2905301.
- [16] D. Nallaperuma *et al.*, "Online incremental machine learning platform for big data-driven smart traffic management," *IEEE Transactions on Intelligent Transportation Systems*, vol. 20, no. 12, pp. 4679–4690, Dec. 2019, doi: 10.1109/TITS.2019.2924883.
- [17] S. Schulz, M. Becker, M. R. Groseclose, S. Schadt, and C. Hopf, "Advanced MALDI mass spectrometry imaging in pharmaceutical research and drug development," *Current Opinion in Biotechnology*, vol. 55, pp. 51–59, Feb. 2019, doi: 10.1016/j.copbio.2018.08.003.
- [18] C. Shang and F. You, "Data analytics and machine learning for smart process manufacturing: recent advances and perspectives in the big data era," *Engineering*, vol. 5, no. 6, pp. 1010–1016, Dec. 2019, doi: 10.1016/j.eng.2019.01.019.
- [19] Y. Yu, M. Li, L. Liu, Y. Li, and J. Wang, "Clinical big data and deep learning: applications, challenges, and future outlooks," *Big Data Mining and Analytics*, vol. 2, no. 4, pp. 288–305, Dec. 2019, doi: 10.26599/BDMA.2019.9020007.
- [20] M. Huang, W. Liu, T. Wang, H. Song, X. Li, and A. Liu, "A queuing delay utilization scheme for on-path service aggregation in services-oriented computing networks," *IEEE Access*, vol. 7, pp. 23816–23833, 2019, doi: 10.1109/ACCESS.2019.2899402.
- [21] G. Xu, Y. Shi, X. Sun, and W. Shen, "Internet of things in marine environment monitoring: a review," *Sensors (Switzerland)*, vol. 19, no. 7, p. 1711, Apr. 2019, doi: 10.3390/s19071711.
- [22] M. Aqib, R. Mehmood, A. Alzahrani, I. Katib, A. Albeshri, and S. M. Altowajiri, "Smarter traffic prediction using big data, in-memory computing, deep learning and gpus," *Sensors (Switzerland)*, vol. 19, no. 9, p. 2206, May 2019, doi: 10.3390/s19092206.



- [23] S. Leonelli and N. Tempini, *Data journeys in the sciences*, Cham: Springer International Publishing, 2020.
- [24] N. Stylos and J. Zwiegelaar, "Big data as a game changer: how does it shape business intelligence within a tourism and hospitality industry context?," in *Big Data and Innovation in Tourism, Travel, and Hospitality: Managerial Approaches, Techniques, and Applications*, Singapore: Springer Singapore, 2019, pp. 163–181.
- [25] Q. Song, H. Ge, J. Caverlee, and X. Hu, "Tensor completion algorithms in big data analytics," *ACM Transactions on Knowledge Discovery from Data*, vol. 13, no. 1, pp. 1–48, Feb. 2019, doi: 10.1145/3278607.
- [26] L. T. M. Blessing and A. Chakrabarti, "DRM: a design research methodology," in *DRM, a Design Research Methodology*, London: Springer London, 2009, pp. 13–42.

BIOGRAPHIES OF AUTHORS





Dr. Apri Siswanto    is senior lecturer at Informatics Department, Faculty of Engineering, Universitas Islam Riau, Pekanbaru, Indonesia. He Holds a Ph.D. degree in Computer Science with specialization in Biometric, Security and Internet of Things from School of Computing, Universiti Utara Malaysia. His research areas are networking, security, biometrics, and internet of things system. He is head of Department of Informatics Engineering, Universitas Islam Riau. His research interests include routing and switching, security, biometrics security, and internet of thing system. He can be contacted at email: aprisiswanto@eng.uir.ac.id.



Akmar Efendi    received the B.Sc. and master degree in computer science from the Universitas Putra Indonesia, Padang, West Sumatra. He is Deputy Dean of student affairs, alumni and cooperation in Faculty of Engineering, Universitas Islam Riau. He is also chair of informatics and computer higher education association (APTIKOM Riau) period 2023-2027. His research interest includes data science, programming and information system. He can be contacted at email: akmarefendi@eng.uir.ac.id.



Dr. Evizal Abdul Kadir    received the M.Eng. and Ph.D. degrees in wireless communication from the Faculty of Electrical Engineering, Universiti Teknologi Malaysia, Malaysia, in 2008 and 2014, respectively. He is currently an Associate Professor in Universitas Islam Riau, Indonesia. He has been involved in several companies that provide telecommunication and radio frequency identification (RFID) system solutions. He is continuing his research on wireless and mobile communication, computer networking and information system, RFID, and wireless sensor network (WSN). His research interest includes in the field of antenna, RF, smart system, RFID, WSN, computer networking, and intelligent system. He can be contacted at email: evizal@eng.uir.ac.id.

ORIGINALITY REPORT

12%

SIMILARITY INDEX

8%

INTERNET SOURCES

12%

PUBLICATIONS

8%

STUDENT PAPERS

PRIMARY SOURCES

1

www2.mdpi.com

Internet Source

3%

2

Kholidiyah Masykuroh, Fikra Titan Syifa, Gatot Rizky Setiyanto, Afifah Dwi Ramadhani, Danny Kurnianto, Nanda Iryani. "Prototype Smart Door Lock By Using Wireless Network Based on Arduino Uno", 2021 IEEE International Conference on Communication, Networks and Satellite (COMNETSAT), 2021

Publication

2%

3

Akmar Efendi, Apri Siswanto, Adrian Sudarman. "Application Control and Monitoring of Light Usage in Smart Home Environment", 2018 Third International Conference on Informatics and Computing (ICIC), 2018

Publication

1%

4

repository.usd.ac.id

Internet Source

1%

5

Tole Sutikno, Moh Ainur Faqih Ubaidillah, Watra Arsadiando, Hendril Satrian Purnama.

1%

"Fingerprint based smart door lock system using Arduino and smartphone application", Computer Science and Information Technologies, 2024

Publication

6

Sri Yuliani, Arimuliani Ahmad, Ikel Srinoviati. "Sociolinguistics perspectives on gender patterns in instagram", Journal of Education and Learning (EduLearn), 2020

Publication

1 %

7

Nanang Husin, Achmad Nizar Hidayanto. "Using Human Heartbeat as a Biometric Using Arduino's Simple Implementation for Further Application", 2019 7th International Conference on Cyber and IT Service Management (CITSM), 2019

Publication

1 %

8

Submitted to Higher Education Commission Pakistan

Student Paper

1 %

9

Submitted to Universiti Teknologi MARA

Student Paper

1 %

10

jjcit.org

Internet Source

1 %

Exclude bibliography On