

Cek Turnitin - Jurnal -
Geotechnics Analysis: Soil
Hardness on Stability of Davit
Kecil's Weir in Ulu Maras,
Kepulauan Anambas,
Kepulauan Riau

by Cek Turnitin Jurnal

Submission date: 16-Mar-2023 11:00AM (UTC+0700)

Submission ID: 2038299176

File name: 91584.pdf (1.43M)

Word count: 4022

Character count: 18964

Geotechnics Analysis: Soil Hardness on Stability of Davit Kecil's Weir in Ulu Maras, Kepulauan Anambas, Kepulauan Riau

Miftahul Jannah¹, Dewandra Bagus Eka Putra¹, Firman Syarif², Joni Triparadi³, Nopiyanto³ and Husnul Kausarian¹

¹Department of Geological Engineering, Universitas Islam Riau, Pekanbaru, Indonesia

²Department of Civil Engineering, Universitas Islam Riau, Pekanbaru, Indonesia

³Water Resources, Department of Public Works and Housing, Kepulauan Anambas, Indonesia

Keywords: Geotechnics, Weir Stability, Sieve Analysis, Direct Shear Stress, Kepulauan Riau.

Abstract: Davit Kecil's weir is an irrigation area that located in Ulu Maras Village, East Jemaja District, Kepulauan Anambas Regency, Kepulauan Riau Province. The needs of a geotechnical study are important to determine the soil properties and soil stability of the study area, those parameters will be used to identify the stability of the weir structure. Methods used are field study by taking soil samples and conduct laboratory analysis such as sieve analysis, hydrometer analysis, atterberg limits and direct shear stress that useful for soil resistance identification. Based on the laboratory test result, Hb.2 and Hb.3 are non-plastic soils with uniformity coefficient are 20.92 – 45.38 and coefficient of gradation is 6 – 15.68. So, the soils as categorized as very good on uniformity and good on gradation. The value of direct shear stress with cohesion (c) is 0.06 and ϕ obtained were in the range of 33.78 – 34.33. Soil grain size identified from sieve analysis is gravel-clay. Based on the analysis result, the stability of Davit Kecil's weir that was observed from normal water condition and flood water condition is categorized into strong-safe weir characterized by sufficient eccentricity and bearing capacity control. In addition, the weir is withstand rolling and sliding failures.

1 INTRODUCTION

Weir is an across building on river channel that functions to raise the river's water level. Weir is a solution in various problems that related to water resources, utilization, management and preservation (Sadono et al., 2017). It was commonly built from soil and rock materials (Athani et al., 2015), that collected a water reserve as a reservoir in order to maintain stable water supply both in rainy and dry seasons (Sompie et al., 2015). Weir is a building that perpetually related with the water (Harseno and Daryanto, 2008). It could also be defined as a building that planted in the river or water flow to deflect water into irrigation (Gunasti, 2016; Putra et al., 2016).

Jemaja's irrigation area is located in Jemaja Island, Kepulauan Anambas Regency, Kepulauan Riau Province. Based on the regulation from Ministry of Public Works and Housing (PUPR) No.14/PRT/M/2015 about The Criteria and Stipulation of Irrigation Area Status, Kepulauan Anambas Regency has the authorization of irrigation

area as wide as ± 386 ha. A study by BWS Sumatra IV said this time around 637,48 ha Irrigation Area was indicated as irrigation area and $\pm 793,43$ ha that has the potency to be convert into irrigation area.

As a follow-up, the management of irrigation that could be utilized effectively and optimally then developed an irrigation area that potentially as an irrigation area. Other than that, the aims to plan the development irrigation area should estimating the technique, economical and environmental aspects.

The weir conditions need to fulfill several factors to be stable and able to control a flood condition. The weir construction should be calculated the strength of bearing capacity of subsurface soil, the weir must be able to hold-out a seepage caused by river water flow and water infiltration into the soil, the weir height must be able to fulfill the minimum water level which is needed for the whole irrigation area and the form of a boiler must be calculated so the water can transport a sand, gravel and any stones from upstream and not cause damage to the weir's body (Erman and M., 2010).

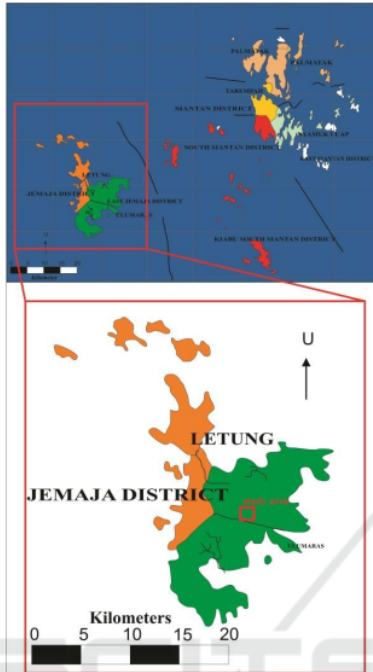

Figure 1: The administration map of Kepulauan Anambas regency.

2 METHODOLOGY

Methods used in this study are field survey, laboratory analysis and the calculation of dam stability. The explanation of each analysis is as follows:

2.1 Field Survey

The field survey was done to obtain primary data such as planning location, identified soil layers by using borehole data in several points. In addition, drilling is done to take soil sample which would be analyzed in the laboratory (Susanto H, 2014). Field survey also conducted by using hand bore that useful to find out the soil layers on the subsurface. The standard procedure that used in hand bore work is ASTM D – 1452 – 80. There are 2 boreholes that can be seen in table (1) and figure (1) below.

Based on the Regional Geology Map (Samodra, 1995), in this two points, the study area was include in Granit Anambas Formation. There are granite, granodiorite and syenite in this formation. The general soil condition is grey, brown and pink in colour.

Table 1: Borehole location and soil testing.

No	Location name	Coordinates	
		X	Y
1	HB.2	N2° 55' 19.64"	E1052° 44' 17.83"
2	HB.3	N2° 55' 18.50"	E1052° 44' 18.64"

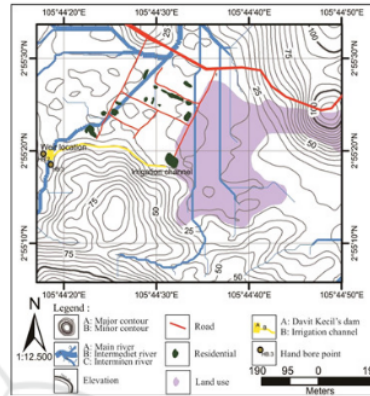

Figure 2: The topography map in the study area shows hand bore points and weir location

2.2 Laboratory Test

Laboratory test consists of undisturbed and disturbed samples taken from selected locations (Sompie et al., 2015). Laboratory test used to determine the most effective and suitable location of dam construction in the study area. Several laboratory tests had been conducted such as sieve analysis, hydrometer analysis, atterberg limits and direct shear stress.

2.2.1 Sieve and Hydrometer Analysis

Sieve and hydrometer analysis are the methods to determine the soil grain size at the borehole points. Soil classification calculated based on particle size from sieve and hydrometer analysis (ASTM, 2007).

There are uniformity coefficient (Cu) and coefficient of gradation (Cc) that obtained from sieve and hydrometer curve. The calculation (1) and (2) are:

$$C_u = \frac{D_{60}}{D_{10}} \quad (1)$$

$$C_c = \frac{D_{30}^2}{D_{10} \times D_{60}} \quad (2)$$

where:

C_c = coefficient of gradation

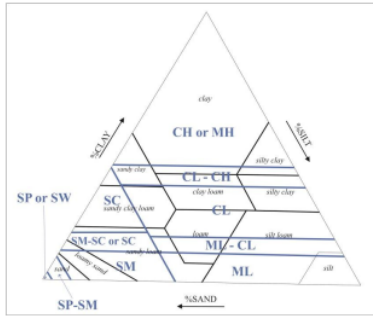

Figure 3: The USCS triangle

- C_u = uniformity coefficient
- D_{10} = diameter of 10% finer
- D_{30} = diameter of 30% finer
- D_{60} = diameter of 60% finer

2.2.2 Atterberg Limit

Atterberg Limit used to identify the soil properties such as Liquid Limit (LL), Plastic Limit (PL) and Plasticity Index (PI). The type of soil can be determined based on the Plasticity Index's (PI) value and then the value is inserted into the plasticity chart. When the atterberg limit's status is non-plastic, the triangle (figure 3) can be used.

Other than that, here is the formula of Atterberg Limits to calculated Plastic limit from ASTM D 424-54 (3), Liquid limit from ASTM D 422 - 66 (4) and Plasticity index from ASTM D 424 - 74 (5).

$$w = \left(\frac{m_2 - m_3}{m_3 - m_1} \right) \times 100\% \quad (3)$$

$$LL = w \times \left(\frac{N^{0.121}}{25} \right) \quad (4)$$

$$PI = LL - PL \quad (5)$$

wherein:

- w = water content (%)
- N = number of beats
- m_1 = container mass (gr)
- m_2 = container mass + wet soil (gr)
- m_3 = container mass + dry soil (gr)
- PI = Plastic Index (%)
- LL = Liquid limit (%)
- PL = Plastic limit (%)

2.2.3 Direct Shear Stress

This test is used to determine the soil shear stress after its experienced a consolidation by loaded with two-way drainage. On the soil mechanics calculation, the direct shear stress is stated as cohesion (c) and deep friction angle (ϕ) (Adama, 2017). The deep friction angle used to determine the main material in the weir.

2.3 Weir Stability

Weir stability analysis is useful to indicating the forces that worked on the weir. The calculation used are own gravity (G), Earthquake force (K), hydrostatic force (W), Mud pressure (L) and uplift pressure (Px). To calculated own gravity and hydrostatic force the weir was partially divide into several shape such as triangles, rectangulars or trapezoid (Ali, 2014). The earthquake coefficient depends on the construction site. In this study area, K is 0,15. According to Radjulaini (2012), on the construction by using stone should not occur tensile stress. Moment of resistance (Mt) must greater than the moment of rolling (Mg) with the safety factor between 1.5-2. The construction should not shift with the safety factor is 1.2-2.

$$E = Wbs.\alpha \quad (6)$$

$$L_p = \frac{\gamma_s.H^2}{2} \cdot \left(\frac{1 - \sin \phi}{1 + \sin \phi} \right) \quad (7)$$

$$P_x = H_x - \frac{L_x}{L}.\Delta H \quad (8)$$

wherein:

- E = earthquake forces (ton)
- Wbs = own gravity in the vertical direction (ton)
- α = earthquake coefficient
- L_p = force located at 2/3 of the depth of the top of the mud that works horizontally (m)
- γ_s = mud specific gravity ($\gamma_s = 1.6 \text{ kN/m}^3$)
- H = thick mud (m)
- ϕ = friction angle in mud ($\phi=20^\circ$)
- Px = uplift force on x point (kg/m^2)
- Hx = height x (m)
- Δ = high difference (m)
- L = total length of creep line on the weir (m)
- Lx = length of creep line until x point (m)

Dam stability in terms of rolling, sliding, eccentricity and soil bearing capacity were calculated. The dam stability analysis is observed from 2 (two) water level conditions, that is normal water condition and flood water condition. The following are formulas used in this calculation.

$$F_x = \frac{\sum MT}{\sum MG} > 1.25 \quad (9)$$

$$F_x = \frac{\sum V \cdot \tan \phi}{\sum H} > 1.00 \quad (10)$$

$$a = \frac{\sum MT - \sum MG}{\sum H} \quad (11)$$

$$e = \frac{B}{2} - a < \frac{B}{6}$$

$$\sigma = \frac{\sum V}{B} \times \left(1 \pm \frac{6e}{B}\right) < \sigma_{ijin} \quad (12)$$

where:

F_x = safety value

$\sum V$ = total of vertical force

$\sum H$ = total of horizontal force

$\sum MT$ = total of the moment of resistance

$\sum MG$ = total of the moment of rolling

e = eccentricity

σ = soil stress ($\sigma_{ijin} = 3.75 \text{ kg/m}^2$)

3 RESULT AND DISCUSSION

The result and discussion of each analysis that has been done in this study are:

3.1 Field Survey

The following are soil layers in the drill point at a depth of 4 meters.

In this location (figure 4), the description of layers soil are:

- At depth 30 – 100 cm there is silty sand, the colour is brownish yellow, solid and low plasticity.
- At depth 100 – 400 cm there is silty clay with sand insert, the colour is yellow, rather soft – medium, medium – high plasticity.

In this location, the description of layer soil (figure 5) is:

- At depth 0 – 50 cm there is sandy-silt with fine sand grains, the colour is brownish yellow, rather loose and hard.
- At depth 50 – 400 cm there is sand with medium sand grains, the colour is yellow, rather loose – solid.

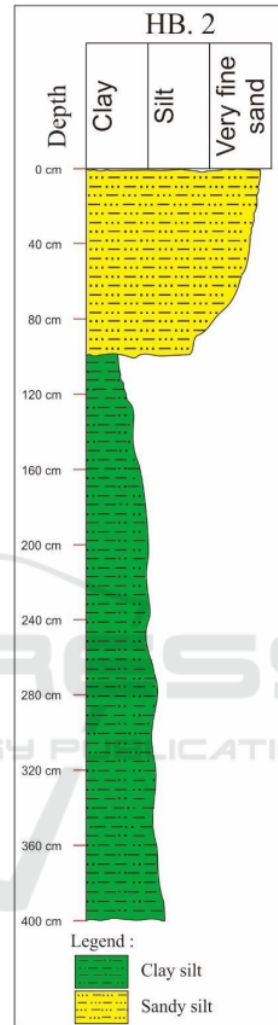

Figure 4: The sediment log at HB.2

3.2 Laboratory Test

The result of laboratory analysis in the study area are sieve and hydrometer analysis, atterbeg limit and direct shear stress.

3.2.1 Sieve and Hydrometer Analysis

There are the result of sieve and hydrometer analysis from the soil samples taken at 3.5 – 4.00 m in each

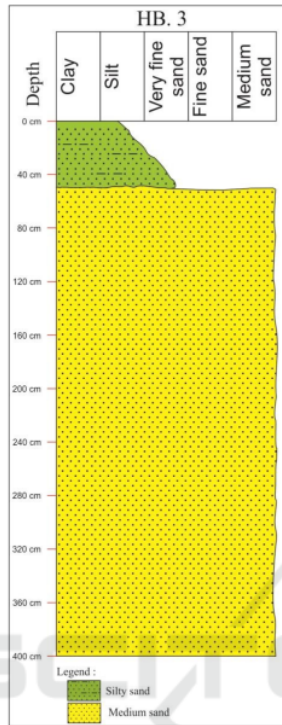

Figure 5: The sediment log at HB.3

borehole. Based on the table below, the value will be plotted into the grain-size curve (figure 6).

From the curve, it could be seen that the result of grain size curve has gap graded because it has a combination of more than 2 fractions with the similar gradation. The type of grain size on sieve analysis from the curve above are gravel – fine sand.

Whereas, hydrometer analysis indicated the grain size type as silt – clay. Based on the classification of grain size, the type of soil is sandy loam (SM) with texture non-sticky and non-plastic (figure 7).

The uniformity coefficient (Cu) calculation and coefficient of gradation were carried out using the diameter value that obtained from the curve are $D_{10} = 0.006$, $D_{30} = 0.15852$ and $D_{60} = 0.2723$.

So, the value of Cu and Cc based on the diameter by curve are 45.38 and 15.68. Accordingly, the soil sample has a very good grain uniformity and good gradation.

For HB.3, the result of sieve and hydrometer analysis are (table 3):

From the curve above, indicated the gap graded

Table 2: Result of Sieve and hydrometer analysis of HB.2

	Sieve number	HB.2	
		Diameter (mm)	Percentage (%)
S I E V E	0	0.00	100.0
	4	4.75	96.80
	10	2.00	95.60
	20	0.85	95.10
	30	0.6	94.20
	40	0.425	89.00
	60	0.25	64.70
	100	0.15	29.50
	200	0.075	29.00
H Y D R O M E T E R	H	0.073	27.07
	Y	0.052	26.14
	D	0.038	25.22
	R	0.028	23.37
	O	0.019	18.75
	M	0.011	15.06
	E	0.008	13.21
	R	0.001	4.9

Table 3: Result of Sieve and hydrometer analysis of HB.3

	Sieve number	HB.3	
		Diameter (mm)	Percentage (%)
S I E V E	0	0.00	100.0
	4	4.75	97.80
	10	2.00	97.20
	20	0.85	96.70
	30	0.6	95.50
	40	0.425	94.60
	60	0.25	89.70
	100	0.15	65.50
	200	0.075	28.90
H Y D R O M E T E R	H	0.073	27.02
	Y	0.052	26.09
	D	0.038	25.17
	R	0.028	21.48
	O	0.019	17.80
	M	0.011	15.03
	E	0.008	12.26
	R	0.001	3.96

soil and has a combination of more than 2 fractions with the same gradation. The type of grain size from sieve analysis are gravel – fine sand. Whereas, from

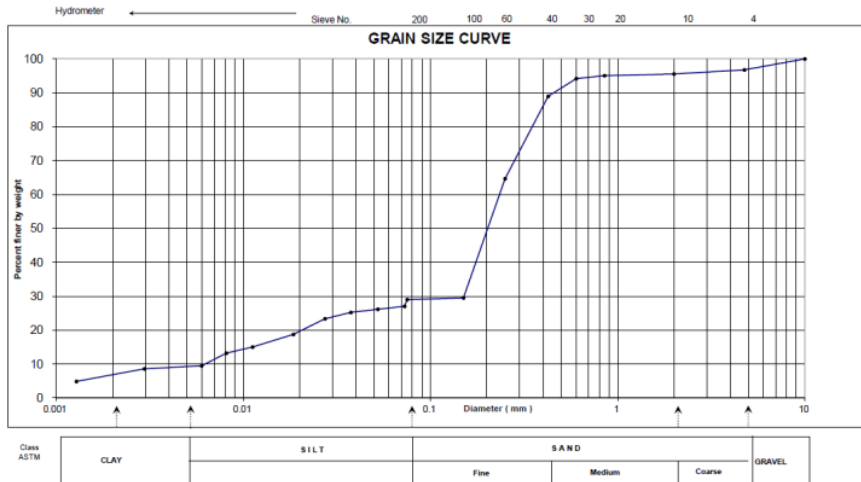

Figure 6: The grain size curve of HB.2

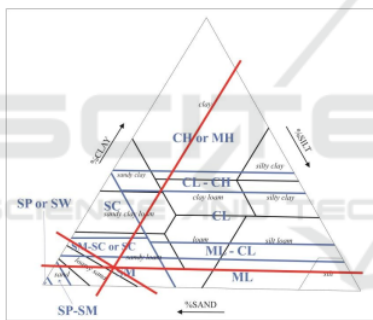

Figure 7: Type soil in HB.2

Table 4: Atterberg Limit analysis result

Drill no.	Depth (m)	Atterberg limits		
		Wl(%)	Wp(%)	Ip(%)
HB.2	3.50- 4.00	*NP	*NP	*NP
HB.3	3.50- 4.00	*NP	*NP	*NP

*NP = non-plastic

This sample has non-plastic properties because at that depth, the soil layers are clay-silt with sand insertion (HB.2) and medium sand (HB.3).

hydrometer analysis shows silt – clay grain size. Soil type determine from the grain class (figure 9).

The uniformity coefficient (Cu) and coefficient of gradation were calculated with diameter value that determine from the curve are $D_{10} = 0.00698$, $D_{30} = 0.075892$ and $D_{60} = 0.146$.

So, the value of Cu and Cc are 20.92 and 6. Accordingly, the soil sampleo has very god uniformity of grain and good gradation.

3.2.2 Atterberg Limits

The atterberg limit analysis that performed were liquid limits, plastic limits and index plastic. The test carried out using the sample from 3,50 m – 4,00 m depth in each borehole. The following are the results of liquid limit, plastic limit and plasticity index.

3.2.3 Direct Shear Stress

This test was done with three-loads, those are 13.4 kg, 28,4 kg and 54.80 kg. After that the value of normal stress and shear stress would be plotted into shear stress graph (figure 10 and figure 11).

The result of direct shear stress from the graph above could be seen in the table below (Table 5).

Table 5: The direct shear stress's value

Bore Number	Cohesion (kg/cm2)	Friction Angle (degree)
(2)	0.06	34.33
(3)	0.06	33.78

From the table above, could be determined the material that used is stone. Whereas the volume weight is 22 kN/m^3 .

Table 7: b. The forces that worked at Davit Kecil's Weir in normal water condition









No	Kind of forces	Moment			
		MT	Direction	MG	Direction
1.	Own gravity	-180.20			
2.	Earthquake force			17.35	
3.	Hydrostatic pressure	-1.48		24.25	
4.	Mud pressure	-1.15		19.87	
5.	Uplift-pressure	11.33		-32.75	
Total		-171.50		28.72	

Table 8: a. The forces that worked at Davit Kecil's Weir in normal water condition















No	Kind of forces	Vertical styles		Horizontal styles	
		V	Direction	H	Direction
1.	Own gravity	-43.07			
2.	Earthquake force			7.69	
3.	Hydrostatic pressure	3.17		15.28	
4.	Mud pressure	0.2		5.71	
5.	Uplift-pressure	-11.06		-15.27	
Total		-34.6	-50.75	13.42	

Table 9: b. The forces that worked at Davit Kecil's Weir in flood water condition

No	Kind of forces	Moment			
		MT	Direction	MG	Direction
1.	Own gravity	-180.20			
2.	Earthquake force			17.35	
3.	Hydrostatic pressure	-14.95		57.77	
4.	Mud pressure	-1.15		19.87	
5.	Uplift-pressure	15.39		-53.32	
Total		-180.92		41.67	

condition) and -180.208 (flood condition). So, the vertical direction from this force is rotated to the right or counter-clockwise (Figure 12).

On the earthquake force, the MG value is 17.35 so as to turn the left or clockwise (Figure 13).

These hydrostatic forces have a two-moment, those are MT and MG that have a different direction. On the normal condition, the MT (righting moment) value is -1.481 and on the flood condition, the MT

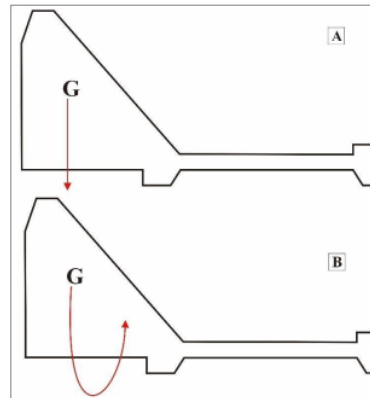

Figure 12: Own gravity on the weir

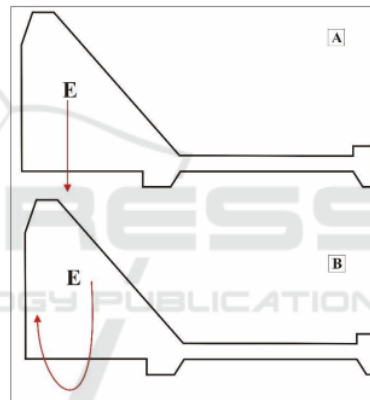

Figure 13: Earthquake force on the weir

(righting moment) value is -14.950. The vertical direction of this force is changed by turn the right or counter-clockwise (Figure 14).

While MG on the normal condition is 24.25 and on the flood condition is 57.77. So the horizontal direction from this force is turned the left or clockwise (Figure 15).

From the table above (6b) (7b), noted that MT value in both conditions is the same, that is -1.15 on the normal and flood condition. So, the vertical direction of this force is changed by turn the right or counter-clockwise (Figure 16).

On the MG, the value of mud pressure is 19.87 on both conditions. So the horizontal direction this force is to turn the left or clockwise (figure 17).

On the uplift-pressure, the MT's value is 11.33 in normal condition and flood condition is 15.39. So

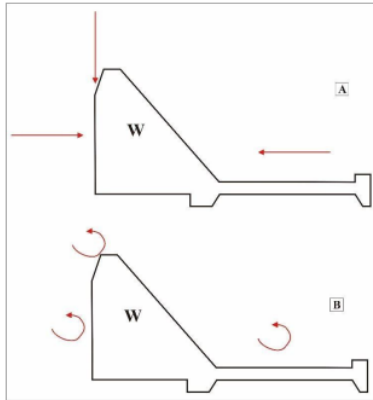

Figure 14: A hydrostatic force of MT

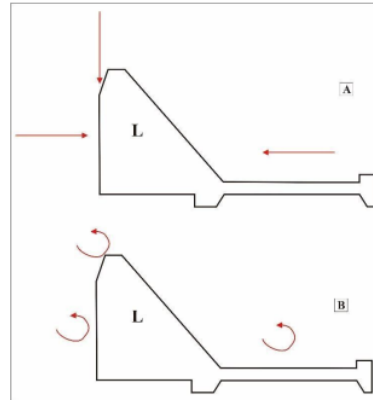

Figure 16: Mud pressure of MT

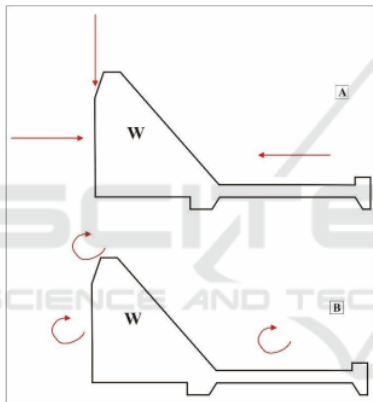

Figure 15: A hydrostatic force of MG

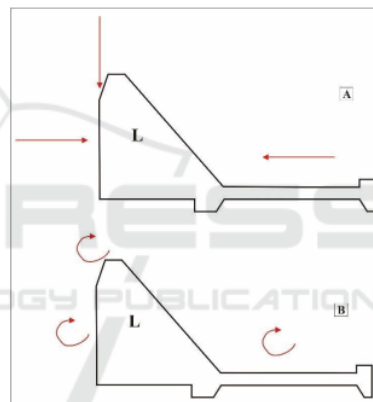

Figure 17: Mud pressure of MG

the horizontal direction of MT is turned the right or counter-clockwise (figure 18).

On the uplift-pressure, the MG's value is -32.75 in normal condition and flood condition is -53.32. So the horizontal direction of MG is turned the left or clockwise (figure 19).

The calculation of weir stability are reviewed from rolling, sliding, eccentricity and soil bearing capacity for each water level conditions, there are normal water condition and flood water condition. The calculation can be seen in the table below.

Based on the calculation above, the control of stability weir by rolling in normal and flood water conditions as strong, that is $\geq 1,5$. Davit Kecil's weir is strong to against shear because in the normal water condition the value is $\geq 1,5$ and flood water condition is $\geq 1,00$. This weir is also safe to eccentricity control

Table 10: The calculation of stability at Davit Kecil's Weir in normal water condition and flood water condition

No.	Weir stability	Water level conditions	
		Normal	Flood
1.	Rolling stability	5.971	-4.341
2.	Sliding stability	-2.676	3.706
3.	Eccentricity stability	a	4.127 m
		e	-0.127 m
4.	Soil bearing capacity	c	0.391
		c	1.232
		c	0.474
		c	0.037
		kg/cm ³	kg/cm ³
		kg/cm ³	kg/cm ³

with value $-0,127 \geq 1,333$ in normal water condition and in flood water condition is $1,256 \geq 1,333$. The soil bearing capacity at this weir was done twice in water level conditions with the terms of value $\leq \sigma_{ijin}$ is 3,75

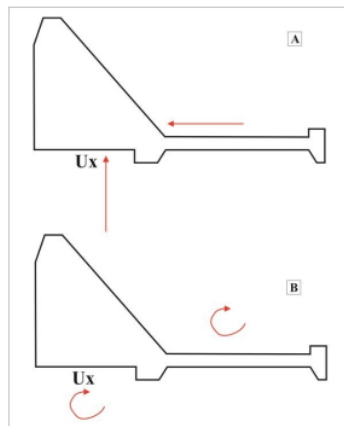

Figure 18: Uplift-pressure of MT

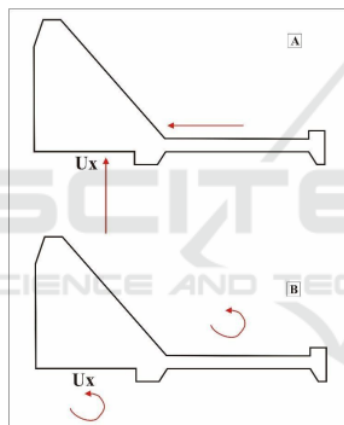

Figure 19: Uplift-pressure of MG

kg/cm^3 . The normal water condition with value σ_1 is $0,391 kg/cm^3$ and σ_2 is $0,474 kg/cm^3$, while in flood water condition with value σ_1 is $1,232 kg/cm^3$ and σ_2 is $0,037 kg/cm^3$. So it is concluded that Davit Kecil's weir in 2 water level conditions has fulfilled that are strongly resist of rolling, strongly resist of sliding, safe of eccentricity and strongly resist of soil bearing capacity.

4 CONCLUSION

Based on the result and discussion in the study area above, then conclusions could be drawn as follows:

- Safety factor to rolling mode is greater than the

minimum safety factor requirement.

- Safety factor to sliding mode is greater than the minimum safety factor.
- Safety factor to eccentricity mode is safe.
- Safety factor to bearing soil capacity is in the range of requirement value for wire building.

ACKNOWLEDGMENTS

Thanks to the Department of Public Works and Housing (Dinas PUPR) Kepulauan Anambas that giving permission and access to the study area.

REFERENCES

- Adama, R. A. (2017). *Correlation of Soil Bearing Capacity with Shear Strength Using Vane Shear and Direct Shear Stress Tools*. Universitas Lampung (Thesis).
- Ali, I. M. (2014). *Tinjauan Kestabilan Bendung Alopohu di Kabupaten Gorontalo*. Universitas Negeri Gorontalo (Thesis).
- ASTM (2007). Astm d422-63: Standard test method for particle-size analysis of soils.
- Athani, S. S., Solanki, C., Dodagoudar, G., et al. (2015). Seepage and stability analyses of earth dam using finite element method. *Aquatic Procedia*, 4:876–883.
- Erman, M. M. and M. (2010). *Desain Bendung Tetap untuk Irigasi*. Bandung: Alfabeta.
- Gunasti, Z. K. N, S. A. (2016). Kajian teknis dam sembah patrang kabupaten jember. *Jurnal Rekayasa Infrastruktur Hexagon*, 1(1).
- Harseno, E. and Daryanto, E. (2008). Tinjauan tinggi tekanan air di bawah bendung dengan turap dan tanpa turap pada tanah berbutir halus. *Majalah Ilmiah UKRIM Edisi*, 2.
- Putra, D. B. E., Choanji, T., et al. (2016). Preliminary analysis of slope stability in kuok and surrounding areas. *Journal of Geoscience, Engineering, Environment, and Technology*, 1(1):41–44.
- Sadono, K. W., Goji, P., Rachdian, E. S., and Tommy, S. (2017). Analisis geologi teknik pada kegagalan bendung cipamingkis, bogor. *Provinsi Jawa Barat. Proceeding Seminar Nasional Kebumian ke*, 10.
- Samodra, H. (1995). *Geological Map of The Tarempa and Jemaja Sheet*. Riau.
- Sompie, O. B. A., S., D., and Ilyas, T. (2015). (2015). *Pengaruh Proses Konsolidasi Terhadap Deformasi dan Faktor Keamanan Lereng Embankment (Studi Kasus Bendungan Kosinggolan)*. *Prosiding seminar Teknik Sipil*, 1.

Cek Turnitin - Jurnal - Geotechnics Analysis: Soil Hardness on Stability of Davit Kecil's Weir in Ulu Maras, Kepulauan Anambas, Kepulauan Riau

ORIGINALITY REPORT

7 %

SIMILARITY INDEX

7 %

INTERNET SOURCES

3 %

PUBLICATIONS

1 %

STUDENT PAPERS

MATCH ALL SOURCES (ONLY SELECTED SOURCE PRINTED)

4%

★ ifory.id

Internet Source

Exclude quotes On

Exclude matches < 1%

Exclude bibliography On